



THE ALL-NEW

ADV150

URBAN ADVENTURER

OWNER'S MANUAL

• WARRANTY POLICY



ADV150

*14 Point Free Check-Up

REGISTER NOW!!!
FOR A HASSLE FREE
WARRANTY

This manual should be considered a permanent part of the vehicle and should remain with the vehicle when it is resold.

This publication includes the latest production information available before printing. Honda Motor Co., Ltd. reserves the right to make changes at any time without notice and without incurring any obligation.

No part of this publication may be reproduced without written permission.

The vehicle pictured in this owner's manual may not match your actual vehicle.

Welcome

Congratulations on your purchase of a new Honda vehicle. Your selection of a Honda makes you part of a worldwide family of satisfied customers who appreciate Honda's reputation for building quality into every product.

To ensure your safety and riding pleasure:

- Read this owner's manual carefully.
- Follow all recommendations and procedures contained in this manual.
- Pay close attention to safety messages contained in this manual and on the vehicle.
- The following codes in this manual indicate each country.

- The illustrations here in are based on the ADV150A IN type.

Country Codes

Code	Country
------	---------

ADV150

IN	Indonesia
----	-----------

ADV150A

IN	Indonesia
PH, II PH	Philippines

*The specifications may vary with each locale.

A Few Words About Safety

Your safety, and the safety of others, is very important. Operating this vehicle safely is an important responsibility.

To help you make informed decisions about safety, we have provided operating procedures and other information on safety labels and in this manual. This information alerts you to potential hazards that could hurt you or others.

Of course, it is not practical or possible to warn you about all hazards associated with operating or maintaining a vehicle. You must use your own good judgement.

You will find important safety information in a variety of forms, including:

- Safety labels on the vehicle
- Safety Messages preceded by a safety alert symbol  and one of three signal words: DANGER, WARNING, or CAUTION.

These signal words mean:

DANGER

You **WILL** be **KILLED** or **SERIOUSLY HURT** if you don't follow instructions.

WARNING

You **CAN** be **KILLED** or **SERIOUSLY HURT** if you don't follow instructions.

CAUTION

You **CAN** be **HURT** if you don't follow instructions.

Other important information is provided under the following titles:

NOTICE

Information to help you avoid damage to your vehicle, other property, or the environment.

Contents

Vehicle Safety P. 2

Operation Guide P. 14

Maintenance P. 68

Troubleshooting P. 106

Information P. 128

Specifications P. 143

Index P. 146

Vehicle Safety

This section contains important information for safe riding of your vehicle.
Please read this section carefully.

Safety Guidelines	P. 3
Safety Precautions	P. 6
Riding Precautions	P. 7
Accessories & Modifications	P. 11
Loading	P. 12

Safety Guidelines

Follow these guidelines to enhance your safety:

- Perform all routine and regular inspections specified in this manual.
- Stop the engine and keep sparks and flame away before filling the fuel tank.
- Do not run the engine in enclosed or partly enclosed areas. Carbon monoxide in exhaust gases is toxic and can kill you.

Always Wear a Helmet

It's a proven fact: helmets and protective apparel significantly reduce the number and severity of head and other injuries. So always wear an approved helmet and protective apparel. 📖 P. 6

Before Riding

Make sure that you are physically fit, mentally focused and free of alcohol and drugs. Check

that you and your passenger are both wearing an approved helmet and protective apparel. Instruct your passenger on holding onto the grab rails or your waist, leaning with you in turns, and keeping their feet on the footpegs, even when the vehicle is stopped.

Take Time to Learn & Practice

Even if you have ridden other vehicles, practice riding in a safe area to become familiar with how this vehicle works and handles, and to become accustomed to the vehicle's size and weight.

Ride Defensively

Always pay attention to other vehicles around you, and do not assume that other drivers see you. Be prepared to stop quickly or perform an evasive maneuver.

Make Yourself Easy to See

Make yourself more visible, especially at night, by wearing bright reflective clothing, positioning yourself so other drivers can see you, signaling before turning or changing lanes, and using your horn when necessary.

Ride within Your Limits

Never ride beyond your personal abilities or faster than conditions warrant. Fatigue and inattention can impair your ability to use good judgement and ride safely.

Don't Drink and Ride

Alcohol and riding don't mix. Even one alcoholic drink can reduce your ability to respond to changing conditions, and your reaction time gets worse with every additional drink. Don't drink and ride, and don't let your friends drink and ride either.

Keep Your Honda in Safe Condition

It's important to keep your vehicle properly maintained and in safe riding condition. Inspect your vehicle before every ride and perform all recommended maintenance. Never exceed load limits (➤ P. 12), and do not modify your vehicle or install accessories that would make your vehicle unsafe (➤ P. 11).

If You are Involved in a Crash

Personal safety is your first priority. If you or anyone else has been injured, take time to assess the severity of the injuries and whether it is safe to continue riding. Call for emergency assistance if needed. Also follow applicable laws and regulations if another person or vehicle is involved in the crash.

If you decide to continue riding, first turn the ignition switch to the **O** (Off) position, and evaluate the condition of your vehicle. Inspect for fluid leaks, check the tightness of critical nuts and bolts, and check the handlebar, control levers, brakes, and wheels. Ride slowly and cautiously.

Your vehicle may have suffered damage that is not immediately apparent. Have your vehicle thoroughly checked at a qualified service facility as soon as possible.

Carbon Monoxide Hazard

Exhaust contains poisonous carbon monoxide, a colourless, odorless gas. Breathing carbon monoxide can cause loss of consciousness and may lead to death.

If you run the engine in confined or even partly enclosed area, the air you breathe could contain a dangerous amount of carbon monoxide.

Never run your vehicle inside a garage or other enclosure.

⚠ WARNING

Running the engine of your vehicle while in an enclosed or even partially enclosed area can cause a rapid build-up of toxic carbon monoxide gas.

Breathing this colourless, odorless gas can quickly cause unconsciousness and lead to death.

Only run your vehicle's engine when it is located in a well ventilated area outdoors.

Safety Precautions

Safety Precautions

- Ride cautiously and keep your hands on the handlebar and feet on the floor.
- Keep passenger's hands onto the grab rails or your waist, passenger's feet on the footpegs while riding.
- Always consider the safety of your passenger, as well as other drivers and riders.

Protective Apparel

Make sure that you and any passenger are wearing an approved helmet, eye protection, and high-visibility protective clothing. Ride defensively in response to weather and road conditions.

■ Helmet

Safety-standard certified, high-visibility, correct size for your head

- Must fit comfortably but securely, with the chin strap fastened.

- Face shield with unobstructed field of vision or other approved eye protection

⚠ WARNING

Not wearing a helmet increases the chance of serious injury or death in a crash.

Make sure that you and any passenger always wear an approved helmet and protective apparel.

■ Gloves

Full-finger leather gloves with high abrasion resistance

■ Boots or Riding Shoes

Sturdy boots with non-slip soles and ankle protection

■ Jacket and Trousers

Protective, highly visible, long-sleeved jacket and durable trousers for riding (or a protective suit)

Riding Precautions

Running-in Period

During the first 500 km (300 miles) of running, follow these guidelines to ensure your vehicle's future reliability and performance.

- Avoid full-throttle starts and rapid acceleration.
- Avoid hard braking.
- Ride conservatively.

Brakes

Observe the following guidelines:

- Avoid excessively hard braking.
 - ▶ Sudden braking can reduce the vehicle's stability.
 - ▶ Where possible, reduce speed before turning; otherwise you risk sliding out.

- Exercise caution on low traction surfaces.
 - ▶ The tyres slip more easily on such surfaces and braking distances are longer.
- Avoid continuous braking.
 - ▶ Repeated braking, such as when descending long, steep slopes can seriously overheat the brakes, reducing their effectiveness.
- For full braking effectiveness, operate both the front and rear brakes together.

Riding Precautions

■ Anti-lock Brake System (ABS) on Front Wheel

ADV150A

This model equipped with an Anti-lock Brake System (ABS) designed to help prevent the front brake from locking up during hard braking.

- There is no ABS function to the rear wheel.
- ABS does not reduce braking distance. In certain circumstances, ABS may result in a longer stopping distance.
- ABS does not function at speeds below 10 km/h (6 mph).
- The front brake lever may recoil slightly when applying the brakes. This is normal.
- Always use the recommended front/rear tyres to ensure correct ABS operation.

■ Combi Brake

ADV150

Your vehicle is equipped with a brake system that distributes the braking force between the front and rear brakes.

The distribution of the braking force applied to the front and rear brakes when operating the front brake lever only and when operating the rear brake lever only is different.

For full braking effectiveness, operate both the front and rear brakes together.

Wet or Rainy Conditions

Road surfaces are slippery when wet, and wet brakes further reduce braking efficiency.

Exercise extra caution when braking in wet conditions.

If the brakes get wet, apply the brakes while riding at low speed to help them dry.

Parking

- Park on a firm, level surface.
- If you must park on a slight incline or loose surface, park so that the vehicle cannot move or fall over.
- Make sure that high-temperature parts cannot come into contact with flammable materials.
- Do not touch the engine, muffler, brakes and other high-temperature parts until they cool down.

- To reduce the likelihood of theft, always lock the handlebar, lock the ignition switch (➤ P. 39) and leave your vehicle while taking the Honda SMART Key with you. Deactivate the Honda SMART Key system if necessary.

➤ P. 34

Use of an anti-theft device is also recommended.

Also set the anti-theft alarm system.

Parking with the Side Stand or Centre Stand

1. Stop the engine.
2. **Using the side stand**

Push the side stand down.

Slowly lean the vehicle to the left until its weight rests on the side stand.

Using the centre stand

To lower the centre stand, stand on the left side of the vehicle.

Hold the left handle grip and the grab rail.

Press down on the tip of the centre stand with your right foot and, simultaneously, pull up and back.

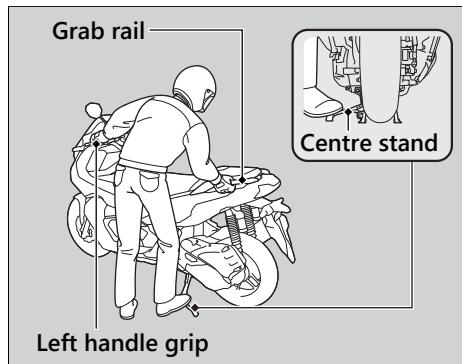

3. Turn the handlebar fully to the left.
 - ▶ Turning the handlebar to the right reduces stability and may cause the vehicle to fall.
4. Turn the ignition switch to the  (Lock) position (➔ P. 32) and lock the ignition switch (➔ P. 39).
5. Set the anti-theft alarm system. ➔ P. 41

Refuelling and Fuel Guidelines

Follow these guidelines to protect the engine, fuel system and catalytic converter:

- Use only unleaded petrol.
- Use recommended octane number. Using lower octane petrol will result in decreased engine performance.
- Do not use fuels containing a high concentration of alcohol. ➔ P. 141
- Do not use stale or contaminated petrol or an oil/petrol mixture.
- Avoid getting dirt or water in the fuel tank.

Accessories & Modifications

We strongly advise that you do not add any accessories that were not specifically designed for your vehicle by Honda or make modifications to your vehicle from its original design. Doing so can make it unsafe. Modifying your vehicle may also void your warranty and make your vehicle illegal to operate on public roads. Before deciding to install accessories on your vehicle be certain the modification is safe and legal.

WARNING

Improper accessories or modifications can cause a crash in which you can be seriously hurt or killed.

Follow all instructions in this owner's manual regarding accessories and modifications.

Do not pull a trailer with, or attach a sidecar to, your vehicle. Your vehicle was not designed for these attachments, and their use can seriously impair your vehicle's handling.

Loading

- Carrying extra weight affects your vehicle's handling, braking and stability. Always ride at a safe speed for the load you are carrying.
- Avoid carrying an excessive load and keep within specified load limits.
Maximum weight capacity / Maximum luggage weight 📖 P. 143
- Tie all luggage securely, evenly balanced and close to the centre of the vehicle.
- Do not place objects near the lights or the muffler.

WARNING

Overloading or improper loading can cause a crash and you can be seriously hurt or killed.

Follow all load limits and other loading guidelines in this manual.

Parts Location

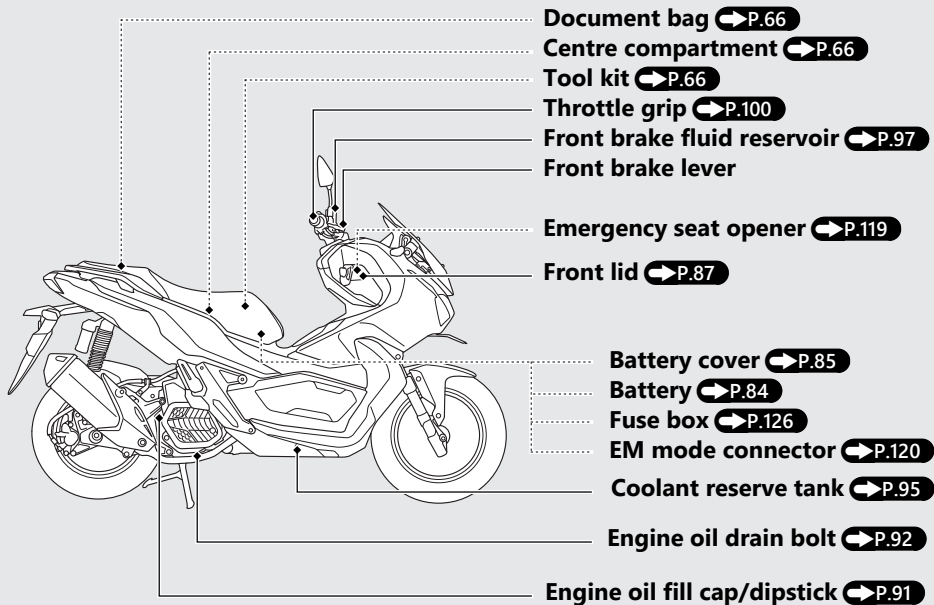

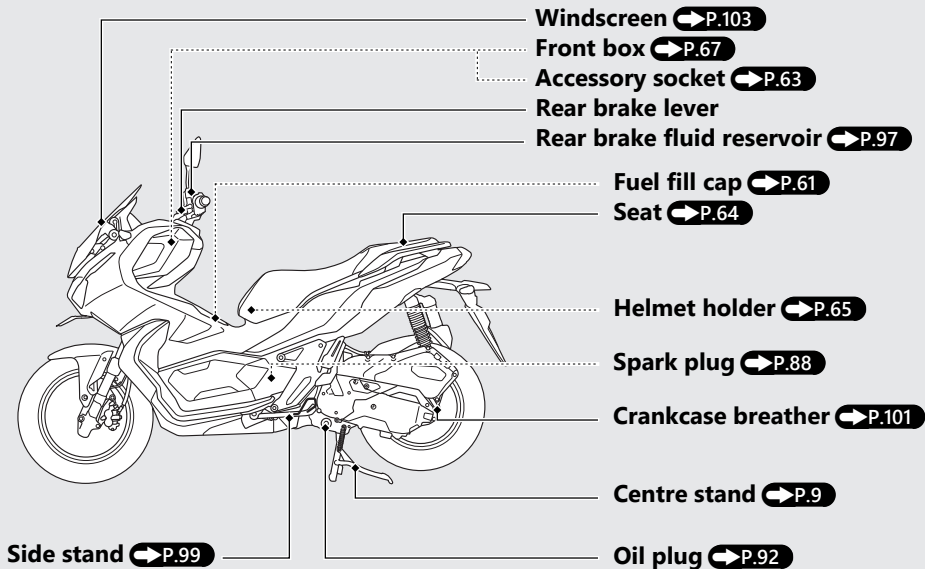

Instruments

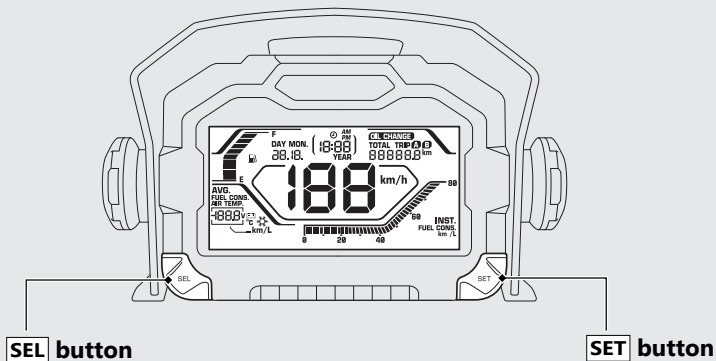

Display Check

When the ignition switch is turned **I** (On), initial animation will show.

If any part of these displays does not come on when it should, have your dealer check for problems.

Date _____
To set the date: ➔ P.23

Clock (12-hour display)
To set the clock: ➔ P.24

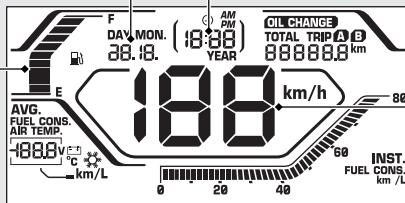

Fuel gauge

Remaining fuel when only 1st (E) segment starts flashing approximately:
 1.0 L (0.26 US gal, 0.22 Imp gal)

If the fuel gauge indicator flashes in a repeat pattern or turns off: ➔ P.113



Speedometer

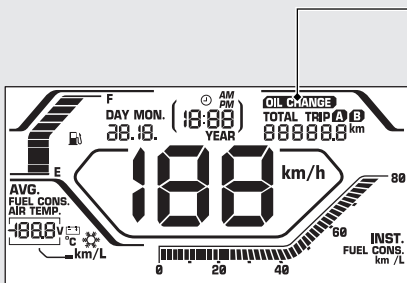

OIL CHANGE indicator

The indicator is turned on whenever the running distance reaches the programmed oil change interval.

When the running distance reaches about 1,000 km (600 miles):

Reset the indicator for the 1st time.

When the running distance reaches about every 6,000 km (4,000 miles) after the 1st time resetting:

Reset the indicator whenever it is turned on.

After changing the engine oil (➔ P. 92), be sure to reset the indicator.

To reset the indicator, press and hold the **SET** button while turning the ignition switch to the **I** (On) position, and keep holding the **SET** button for more than 3 seconds.

The indicator does not go off until it is reset.

If the oil is changed before the oil change indicator comes on, be sure to reset the oil change indicator after changing the oil.

When resetting the indicator during no indication, the indicator will appear for 2 seconds, then disappear.

Instruments *(Continued)*

Odometer

Total distance ridden.

When "-----" is displayed, go to your dealer for service.

Tripmeter A/B

Distance ridden since tripmeter was reset.

- ▶ To reset tripmeter, press and hold **SET** button while tripmeter displayed. When to reset tripmeter, the average fuel mileage is also reset.

Air temperature gauge

Shows ambient temperature.

Display range: -10 to 50°C

- Below -10°C: "---" is displayed
- Above 50°C: 50°C flashes

❄ comes on when air temperature is below 3°C, and goes off when air temperature reaches 5°C after ❄ comes on.

Battery voltage

Current battery voltage.

Average fuel mileage A/B

Displays the average fuel mileage since the selected tripmeter was reset.

The average fuel mileage will be calculated based on value displayed on the tripmeter (A or B) selected. When each tripmeter is reset, each average fuel mileage will also reset.

Display range: 0.0 to 199.9 km/L

Less than 0.1 km/L: "0.0" is displayed

More than 199.9 km/L: "199.9" is displayed

- When the tripmeter A or B is reset: "--.-" is displayed.

When "--.-" is displayed except for the above-mentioned cases, go to your dealer for service.

Switching the Display

The **[SEL]** button switches among the odometer, tripmeter A and tripmeter B. Also **[SEL]** button switches among the battery voltage meter, air temperature gauge and average fuel mileage.

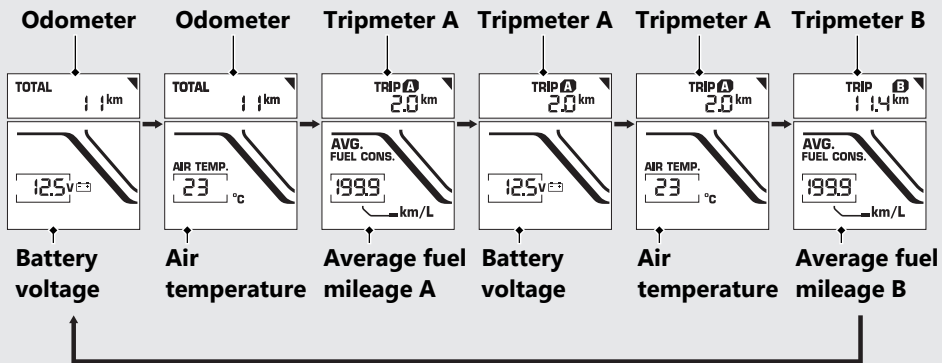

→ Press the **[SEL]** button



Instruments *(Continued)*

Display Setting

Following items to change sequentially.

- Date setting
- Clock setting
- Backlight brightness adjustment
- Activating/deactivating of tripmeter A and average fuel mileage A automatic reset mode

The following moves the ordinary display at display setting.

- The switch is not pressed for about 30 seconds
- Turn the ignition switch to the  (Off) position and then to the  (On) position

To complete the setting for date and clock, it is necessary to finalise the minute in the clock setting or turn the ignition switch to the  (Off) position.

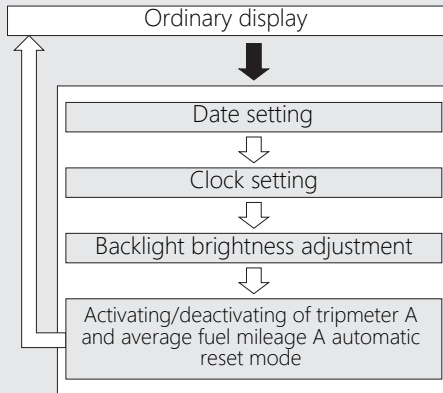

➡ Press and hold **SEL** button and **SET** button

➡ Press **SET** button

1 Date setting:

- 1 Turn the ignition switch to the **I** (On) position.
- 2 Press and hold the **SEL** button and **SET** button, the year digits start flashing.
- 3 Press the **SEL** button until the desired year is displayed.

- ▶ Press and hold the **SEL** button to advance the year fast.



- 4 Press the **SET** button. The month digits start flashing.



- 5 Press the **SEL** button until the desired month is displayed.
 - ▶ Press and hold the **SEL** button to advance the month fast.



- 6 Press the **SET** button. The day digits start flashing.

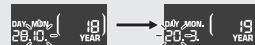

- 7 Press the **SEL** button until the desired day is displayed.
 - ▶ Press and hold the **SEL** button to advance the day fast.



- 8 Press the **SET** button. The date is set, and the display moves to the clock setting.

Instruments *(Continued)*

2 Clock setting:

- 1 Press the **SEL** button until the desired hour is displayed.

- ▶ When the display changes from 11 to 12, AM/PM will switch at the same time.
- ▶ Press and hold the **SEL** button to advance the hour fast.



- 2 Press the **SET** button. The minute digits start flashing.



- 3 Press the **SEL** button until the desired minute is displayed.

- ▶ Press and hold the **SEL** button to advance the minute fast.



- 4 Press the **SET** button. The clock is set, and the display moves to the backlight brightness adjustment.

3 Backlight brightness adjustment:

You can adjust the brightness to one of five levels.

- 1 Press the **SEL** button. The brightness is switched.

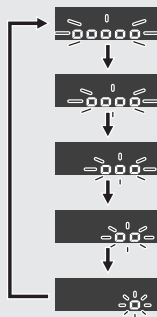

- 2 Press the **SET** button. The brightness level is set, and the display moves to the activating/deactivating of tripmeter A and average fuel mileage A automatic reset mode.

4 To activate/deactivate of tripmeter A and average fuel mileage A automatic reset mode:

You can activate or deactivate the automatic reset mode by refuelling after 1st (E) segment of the fuel gauge start flashing. Activation is initially set.

- 1 Press the **SEL** button to select " *On* " (activate) or " *OFF* " (deactivate) in the automatic reset mode.

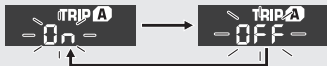

- 2 Press **SET** button. The activation/deactivation of automatic reset mode is set, and the display will return to the ordinary display.

Indicators

If one of these indicators does not come on when it should, have your dealer check for problems.

 **High beam indicator**

 **Idling Stop indicator**

Comes on briefly when the ignition switch is turned **I** (On).

Idling Stop system:  **P.51**

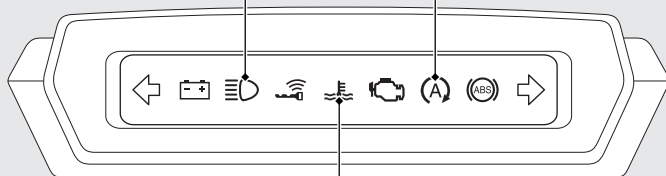

 **High coolant temperature indicator**

If it comes on while riding:

 **P.108**

⇐ **Left turn signal indicator**

⇒ **Right turn signal indicator**

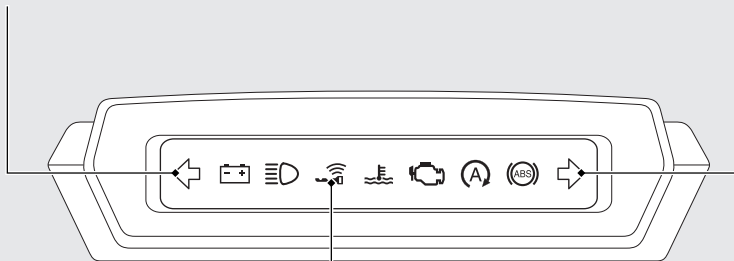

📶 **Honda SMART Key Indicator**

Comes on when vehicle and Honda SMART Key verification is complete, and the ignition switch can be operated.

Goes off when the ignition switch is turned **I** (On).

When the Honda SMART Key Indicator

Flashes: ➡ **P.111**

Indicators (Continued)

PGM-FI (Programmed Fuel Injection) malfunction indicator lamp (MIL)

Comes on briefly when the ignition switch is turned **I** (On).

If it comes on while engine is running: ➔ P.109

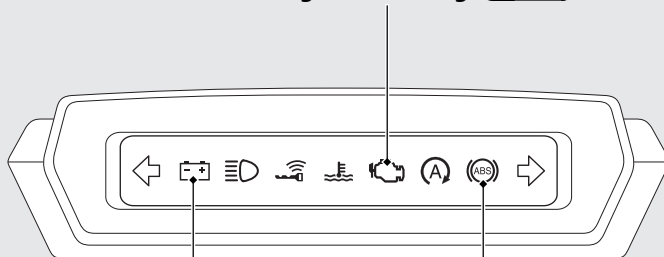

 **Battery Charging Condition indicator**

ADV150A

 **ABS (Anti-lock Brake System) indicator**

Comes on when the ignition switch is turned to the **I** (On) position. Goes off when your speed reaches approximately 10 km/h (6 mph).

If it comes on while riding: ➔ P.110

Switches

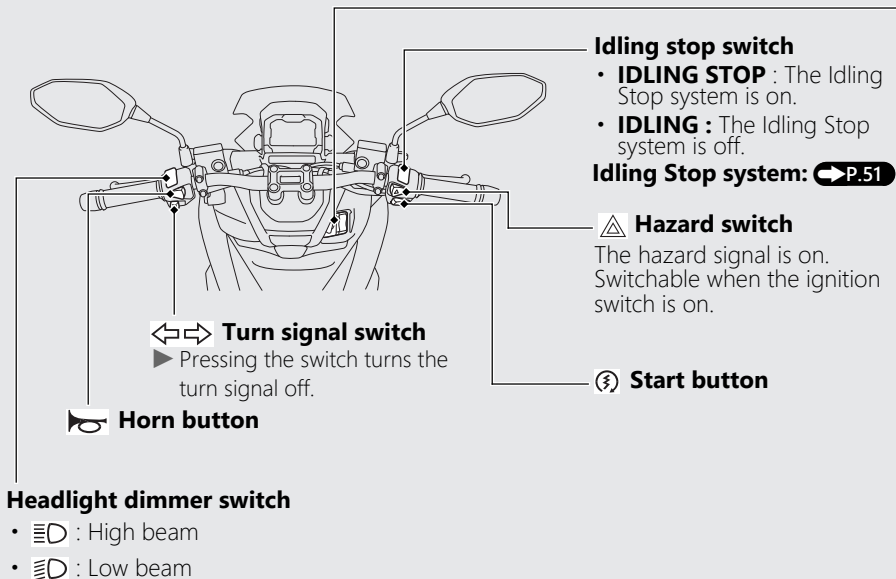

Ignition switch

Switches the electrical system on/off, locks the steering, and operates the fuel lid and seat opener switch.

To unlock the ignition switch:

 P.38

I (On)
Turns electrical system on for starting/riding.

SEAT FUEL
Operates the fuel lid and seat opener switch.

O (Off)
Turns engine off.

LOCK (Lock)
Locks steering.

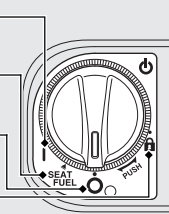

Switches *(Continued)*



Steering Lock

Lock the steering when parking to help prevent theft.

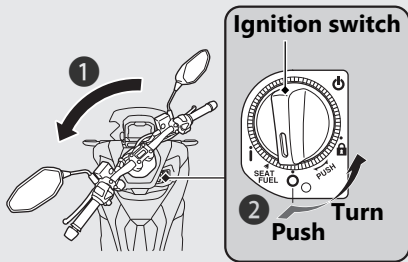
A U-shaped wheel lock or similar device is also recommended.



Locking

- 1 Turn the handlebar all the way to the left or right.
- 2 Push the ignition switch down, and turn it to the  (Lock) position.
 - ▶ To unlock the ignition switch  **P.38**
 - ▶ Jiggle the handlebar if the lock is difficult to engage.
- 3 Lock the ignition switch.

Unlocking

Push the ignition switch in, and turn it to the

- (Off) position.
 - ▶ To unlock the ignition switch  **P.38**

Honda SMART Key System

The Honda SMART Key system allows you to operate the main switch without inserting a key into a keyhole.

The system runs a two-way authentication between the vehicle and the Honda SMART Key to verify if it is the registered Honda SMART Key.

The Honda SMART Key system uses low-intensity radio waves. It may affect medical equipment such as a cardiac pacemakers.

Honda SMART Key System *(Continued)*

Switching the Honda SMART Key System

To switch the Honda SMART Key system to activation or deactivation

Press the ON/OFF button until the LED colour of the Honda SMART Key changes.

To check the Honda SMART Key system status

Lightly press the ON/OFF button. The LED of the Honda SMART Key will show the status.

When the LED of the Honda SMART Key is:

Green: Honda SMART Key system authentication can be performed.

Red: Honda SMART Key system authentication can not be performed.

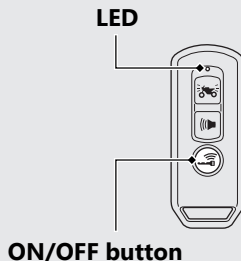

Operating Range

The operating range varies when the ignition switch is locked or unlocked.

The Honda SMART Key system uses low-intensity radio waves. Therefore the operating range may become wider or narrower, or the Honda SMART Key system may not work properly in the following environments.

- When the Honda SMART Key battery is depleted.
- When there are facilities nearby that generate strong radio waves or noise such as TV towers, power stations, radio stations, or airports.
- When you carry the Honda SMART Key with a laptop or wireless communication device such as a radio or mobile phone.
- When the Honda SMART Key comes into contact with or is covered by metal objects.

When the ignition switch is unlocked:

The system can be operated within the shaded area shown in the illustration.

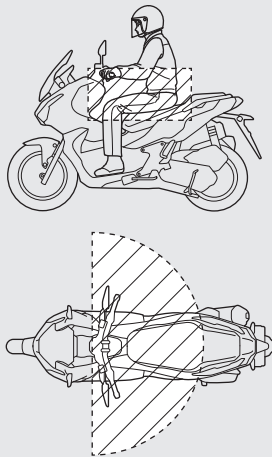

Honda SMART Key System *(Continued)*

When the ignition switch is locked:

The system can be operated within the shaded area shown in the illustration.

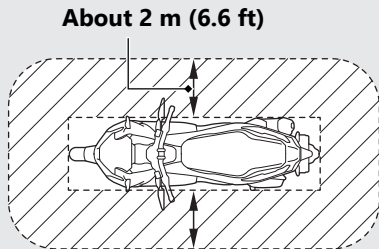

Anyone can unlock the ignition switch and start the engine if your Honda SMART Key is within operating range of your vehicle, even if you are on the other side of a wall or window. If you are away from your vehicle but your Honda SMART Key is still within operating range, deactivate the Honda SMART Key system.

To switching the Honda SMART Key system P.34

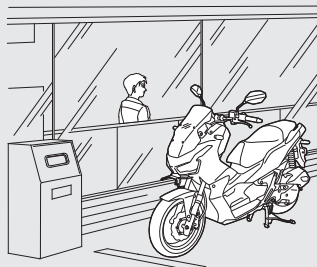

Anyone in possession of the Honda SMART Key can perform the following operations if the Honda SMART Key is within operating range:

- Starting the engine
- Unlocking the ignition switch
- Releasing the seat lock
- Opening the fuel lid
- Unlocking the steering lock

You should always keep the Honda SMART Key on your person after you get on and off the vehicle or while riding.

Do not place the Honda SMART Key in the centre compartment or front box.

If the ignition switch is in the **I** (On) position, the vehicle can be operated even by a person who does not have a verified Honda SMART Key.

Whenever you leave your vehicle, lock the steering and lock the ignition switch.

 **P.39**

Make sure the ignition switch ring goes off and all turn signals flash once at this time.

Honda SMART Key System (Continued)

Switching the ignition switch

To Unlock the Ignition Switch

- 1 Make sure that the Honda SMART Key is activated. **➔P.34**
- 2 To authenticate the Honda SMART Key system, push the ignition switch.
 - ▶ When properly authenticated and the ignition switch is unlocked, the buzzer rings 2 times, the Honda SMART Key indicator and ignition switch ring come on.
 - ▶ The buzzer sound can be cancelled. **➔P.40**
- 3 Turn the ignition switch to the **I** (On) position while the Honda SMART Key indicator comes on.
 - ▶ If you do not turn the ignition switch to the **I** (On) position within 20 seconds after pushing in the ignition switch in, the Honda SMART Key indicator and ignition switch ring will go off, the turn signals flash 1 time, and then the ignition switch will be locked.

When the Honda SMART Key system does not work properly **➔P.117**

If someone without the Honda SMART Key tries to turn the ignition switch, the ignition switch rotates freely. If you notice the ignition switch is in a different position, turn the ignition switch to the original position (O (Off) or **I** (Lock)).

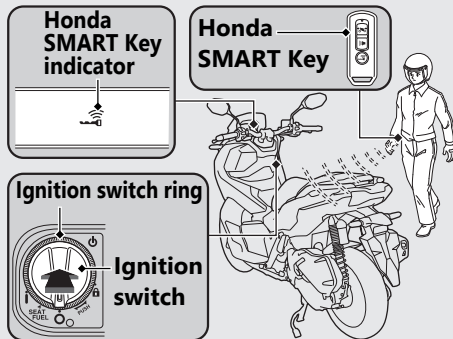



To Lock the Ignition Switch

- 1 Turn the ignition switch to the SEAT FUEL, ○ (Off) or 🔒 (Lock) position.
 - Leave the operating range with the Honda SMART Key. ➡ P.35
 - Push the ignition switch.
 - Wait for approximately 20 seconds after turning the ignition switch from | (On) to SEAT FUEL, ○ (Off) or 🔒 (Lock).
 - Switch the Honda SMART Key system to deactivation. ➡ P.34
- 2 Lock the ignition switch by doing one of the following:
 - Leave the operating range with the Honda SMART Key. ➡ P.35
 - Push the ignition switch.
 - Wait for approximately 20 seconds after turning the ignition switch from | (On) to SEAT FUEL, ○ (Off) or 🔒 (Lock).
 - Switch the Honda SMART Key system to deactivation. ➡ P.34
- 3 Make sure that the Honda SMART Key indicator and ignition switch ring go off, the turn signals flash once, and the buzzer rings 1 time. This indicates that the ignition switch is locked.
 - ▶ The buzzer sound can be cancelled. ➡ P.40

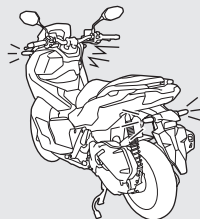
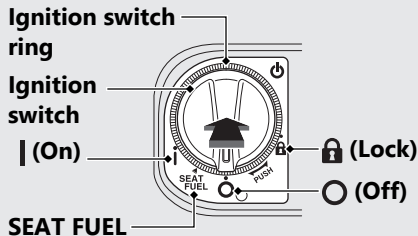
When the Honda SMART Key system does not work properly ➡ P.117



Honda SMART Key System *(Continued)*

Always make sure the ignition switch position is in the  (Off) or  (Lock) position when you leave your vehicle.

When the ignition switch is locked in the SEAT FUEL position, the ignition switch can be turned  (Off) only once.

When the ignition switch is locked in the  (Off) position, the steering cannot be locked. To lock the steering, unlock the ignition switch.

Switch the Buzzer Sound When the Ignition Switch is Locked/Unlocked

Enable

- 1 Deactivate the Honda SMART Key system.
 **P.34**
- 2 Lightly press the ON/OFF button. The red LED of the Honda SMART Key comes on.
- 3 While the red LED is on, press the answer back button.
 - ▶ The red LED starts blinking when the buzzer sound is properly enabled.

Disable

- 1 Deactivate the Honda SMART Key system.
 **P.34**
- 2 Lightly press the ON/OFF button. The red LED of the Honda SMART Key blinks.
- 3 While the red LED is blinking, press the answer back button.
 - ▶ The red LED stops blinking but stays on when the buzzer sound is properly disabled.

Anti-theft Alarm System

The anti-theft alarm system is a device to reduce the likelihood of theft. When the sensor detects vibration or movement with the ignition switch in the **O** (Off) or **L** (Lock) position and the system is set, the alarm is activated.

The buzzer rings and the turn signals blink for about 10 seconds when the anti-theft alarm system detects vibration caused by contact or movement.

The buzzer rings and the turn signals blink for about 60 seconds when the anti-theft alarm system detects a substantial change in the vehicle posture. After the buzzer rings for 60 seconds, the anti-theft alarm system will be reset in that posture.

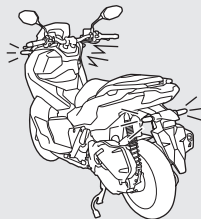
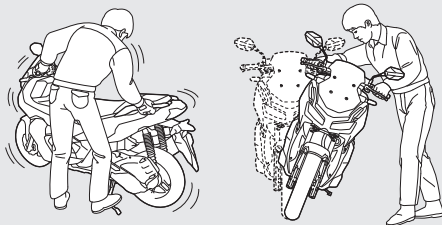

Anti-theft Alarm System *(Continued)*

If the ignition switch is left **○** (Off) for more than 10 days, the anti-theft alarm system will no longer operate. During the system is activating, when the vehicle receives a signal by pressing the answer back button or alarm button, the system activation will be extended for 10 days.

To reset the system, turn the ignition switch **|** (On) once.

The anti-theft alarm system uses low-intensity radio waves. It may affect medical equipment such as a cardiac pacemaker.

NOTICE

When the battery in the vehicle is weak, the anti-theft alarm system may not function.

Setting the Anti-theft Alarm System

- 1 Turn the ignition switch to **○** (Off) or **🔒** (Lock) position.
- 2 Press the alarm button. Within a second, the turn signal light blinks and the buzzer rings 1 time. After 2.5 seconds, the buzzer rings 1 time. The anti-theft alarm system is activated.

The alarm indicator flashes while the anti-theft alarm system is activated.

Alarm button

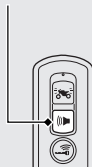

Alarm indicator

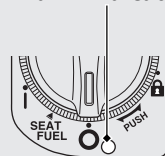

■ Cancelling the Anti-theft Alarm System

To cancel the anti-theft alarm system, press the alarm button on the Honda SMART Key or unlock the ignition switch. ➡P.38

When the anti-theft alarm system is canceled, the turn signal light and alarm indicator blink 2 times, and the buzzer rings 2 times.

Alarm button

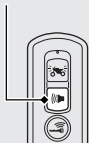

■ Stopping the Anti-theft Alarm Activation

To stop the anti-theft alarm activation, do one of the following:

- Press the alarm button on the Honda SMART Key.
- Press the answer back button on the Honda SMART Key.
- Unlock the ignition switch. ➡P.38

After stopping the anti-theft alarm activation, the anti-theft alarm system will be cancelled.

Alarm button

Answer back button

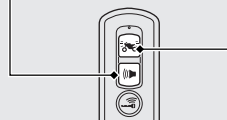

Anti-theft Alarm System *(Continued)*

Adjusting the Sensitivity of Anti-theft Alarm System

You can select from 3 sensitivity levels for the anti-theft alarm system.

- 1 Make sure that the Honda SMART Key system is activated. ➔ **P.34**
- 2 Remove the battery cover. ➔ **P.85**
- 3 Push the ignition switch to authenticate the Honda SMART Key system. ➔ **P.38**
- 4 Connect the EM mode coupler provided in the tool kit to the EM mode connector. ➔ **P.120**
 - ▶ The Honda SMART Key indicator and ignition switch ring go off.

Alarm button

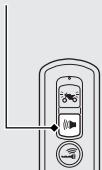

Ignition switch

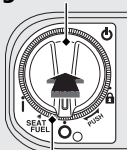

Ignition switch ring

- 5 Push the ignition switch 1 time.
- 6 Repeat this step 3 times as follows:
 - ▶ Press the alarm button on the Honda SMART Key 2 times and the ignition switch 1 time.
 - ▶ When the alarm button is pressed, the LED on the Honda SMART Key comes on. Make sure the LED went off before the next button pressing.
 - ▶ If the alarm button or ignition switch is not pressed for 1 minute, the Honda SMART Key indicator starts blinking and this mode will be cancelled. If so, remove the EM mode coupler, return to 3 and follow the procedure again.



- 7 Press the alarm button to select from 3 sensitivity level of anti-theft alarm system.
3 times of alarm rings: high sensitivity
2 times of alarm rings: middle sensitivity
1 time of alarm rings: low sensitivity
The Honda SMART Key indicator and ignition switch ring come on while setting.
- 8 Wait for about 10 seconds until the ignition switch ring starts blinking. The sensitivity level is set.
- 9 Remove the EM mode coupler from the EM mode connector to finish setting.
 - ▶ The sensitivity level is also set if you remove the EM mode coupler before the ignition switch ring starts blinking.
- 10 Store the EM mode coupler in the tool kit. Reinstall the parts in reverse order.

| If the Anti-Theft Alarm System Does Not Operate Properly

If any of the following situations arise, battery (▶ P. 84) in the vehicle is discharged or there is a system problem. Remove the battery and see your dealer.

- The alarm does not ring.
- The alarm rings but fades out.
- The alarm system does not stop.

Answer Back System

The answer back system is a device to find the location of your vehicle and to inform you that the immobilizer function of the Honda SMART key system is activated. When you press the answer back button on the Honda SMART Key with the ignition switch  (Off) or  (Lock) position, the turn signals light, and the ignition switch ring lights, informing you of your vehicle's location and activation of the immobilizer function. The ignition switch ring will light for about 1 minute.

The answer back system uses low-intensity radio waves. It may affect medical equipment such as a cardiac pacemaker.

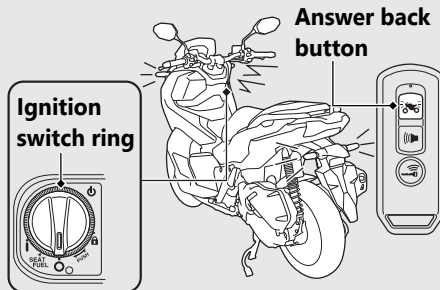

Operation

Press the answer back button on the Honda SMART Key.

- ▶ The answer back system will not function when the ignition switch is **I** (On) position.

If the ignition switch is left the **O** (Off) or **I** (Lock) position for more than 10 days, the answer back system will no longer operate. During the system is activating, when the vehicle receives a signal by pressing the answer back button or alarm button, the system activation will be extended for 10 days.

To reset the system, unlock the ignition switch and turn the ignition switch **I** (On) position once.

- ▶ To unlock the ignition switch **→P.38**

NOTICE

When the battery in the vehicle is weak, the answer back system may not function.

Adjusting the Answer Back Buzzer Sound Volume Level

You can select 3 buzzer sound volume levels.

- 1 Make sure that the Honda SMART Key system is activated. **→P.34**
- 2 Remove the battery cover. **→P.85**
- 3 Push the ignition switch to authenticate the Honda SMART Key system. **→P.38**
- 4 Connect the EM mode coupler provided in the tool kit to the EM mode connector.

→P.120

- ▶ The Honda SMART Key indicator and ignition switch ring go off.

Answer back button



Ignition switch

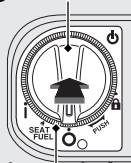

Ignition switch ring

Answer Back System *(Continued)*

- 5 Push the ignition switch 1 time.
- 6 Repeat this step 3 times as follows:
Press the answer back button on the Honda SMART Key 2 times and the ignition switch 1 time.
 - ▶ When the answer back button is pressed, the LED on the Honda SMART Key comes on. Make sure the LED went off before the next button pressing.
 - ▶ If the answer back button or ignition switch is not pressed for 1 minute, the Honda SMART Key indicator starts blinking and this mode will be cancelled. If so, remove the EM mode coupler, return to 3 and follow the procedure again.
- 7 Press the answer back button to select from 3 levels for the sound volume. The Honda SMART Key indicator and ignition switch ring come on while setting.
- 8 Wait for about 10 seconds until the ignition switch ring starts blinking. The sound volume level is set.
- 9 Remove the EM mode coupler from the EM mode connector to finish setting.
 - ▶ The sound volume level is also set if you remove the EM mode coupler before the ignition switch ring starts blinking.
- 10 Store the EM mode coupler in the tool kit. Reinstall the parts in reverse order.

Changing the Answer Back Buzzer Sound Pattern

You can select 3 buzzer sound patterns.

- 1 Make sure that the Honda SMART Key system is activated. ➔ P.34
- 2 Remove the battery cover. ➔ P.85
- 3 Push the ignition switch to authenticate the Honda SMART Key system. ➔ P.38
- 4 Connect the EM mode coupler provided in the tool kit to the EM mode connector. ➔ P.120
 - ▶ The Honda SMART Key indicator and ignition switch ring go off.

Answer back button

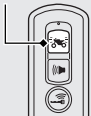

Ignition switch

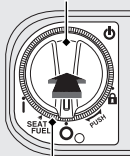

Ignition switch ring

- 5 Push the ignition switch 1 time.
- 6 Repeat this step 3 times as follows:
 - ▶ Press the answer back button on the Honda SMART Key 3 times and the ignition switch 1 time.
 - ▶ When the answer back button is pressed, the LED on the Honda SMART Key comes on. Make sure the LED went off before the next button pressing.
 - ▶ If the answer back button or ignition switch is not pressed for 1 minute, the Honda SMART Key indicator starts blinking and this mode will be cancelled. If so, remove the EM mode coupler, return to 3 and follow the procedure again.

Answer Back System *(Continued)*

- 7 Press the answer back button to select from 3 buzzer sound patterns. The Honda SMART Key indicator and ignition switch ring come on while setting.
- 8 Wait for about 10 seconds until the ignition switch ring starts blinking. The sound pattern is set.
- 9 Remove the EM mode coupler from the EM mode connector to finish setting.
 - ▶ The sound pattern is also set if you remove the EM mode coupler before the ignition switch ring starts blinking.
- 10 Store the EM mode coupler in the tool kit. Reinstall the parts in reverse order.

Temporary Silence Mode

Temporary silence mode is the immediate way to turn off the answer back system buzzer sound.

Enable:

Press and hold the answer back button about 2 seconds, LED on Honda SMART Key is changed to be red.

Disable:

Re-press and hold the answer back button about 2 seconds, LED on Honda SMART Key is changed to be green.

Idling Stop System

Idling Stop system is designed to help reduce the fuel consumption and noise, by idling stop while making a stop such as waiting at an intersection.

Switching the Idling Stop System On or Off

Switches the Idling Stop system on or off using the Idling Stop switch.

- ON: **IDLING STOP**
 - ▶ Idling Stop indicator comes on when the Idling Stop system becomes ready to stop the engine while riding. Idling Stop indicator flashes when the engine is stopped by the Idling Stop system.
- OFF: **IDLING**
 - ▶ Idling Stop indicator does not come on when the Idling Stop system is off.

Activation of the Idling Stop System

The Idling Stop system becomes ready to stop the engine and Idling Stop indicator comes on when the following requirements are satisfied with the Idling Stop switch in the IDLING STOP position:

- start the engine by pressing the start button
- warm up the engine enough
- ride the vehicle at speeds over 10 km/h (6 mph)

Idling Stop Indicator Does Not Come On:

➔ P.114

Idling Stop switch

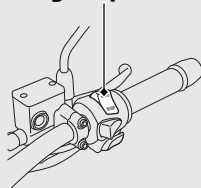

Idling Stop indicator

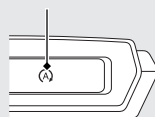

Idling Stop System *(Continued)*

Stopping the engine by the Idling Stop System

The engine stops and Idling Stop indicator changes to flash after you close the throttle completely and stop the vehicle while the Idling Stop indicator is on.

- ▶ While the engine is stopped by the Idling Stop system, if you press the Idling Stop switch to IDLING, the Idling Stop system will be cancelled. The engine will not restart even when you open the throttle.

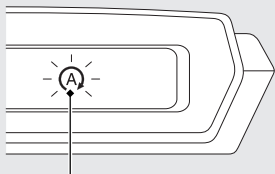

Idling Stop indicator

Safety Precaution for the Idling Stop System

Do not go away from the vehicle while the Idling Stop indicator is flashing. When you go away from the vehicle, always turn the ignition switch to the  (Off) position.

- ▶ The engine may start unexpectedly if the throttle is opened.

Engine is Not Stopped by the Idling Stop System While the Idling Stop Indicator is On:

NOTICE

Stopping by the Idling Stop system for a long time may cause battery discharge.

Restarting the Engine

Check that the Idling Stop indicator is flashing, and then open the throttle.

- ▶ If it is not flashing, you can't restart the engine with the Idling Stop system, even if you open the throttle.
- ▶ While the engine is stopped by the Idling Stop system, if you operate the side stand, the flashing Idling Stop indicator turns off or stops flashing and stays on, then the engine will not restart even when you open the throttle.

Engine Does Not Start Even If the Throttle is Opened: ➡P.116

NOTICE

Headlight stays on after the engine is stopped by the Idling Stop system. The battery may discharge and you may not be able to restart engine.

When the battery is weak, switch the Idling Stop switch to IDLING and do not to use the Idling Stop system. See your dealer to check the battery.

See your dealer for checking the battery as specified in the maintenance schedule.

Maintenance Schedule: ➡P.70

Starting the Engine

Start your engine using the following procedure, regardless of whether the engine is cold or warm.

This vehicle is equipped with a side stand ignition cut-off system.

- ▶ If the side stand is down, the engine cannot be started.
- ▶ If you lower the side stand with the engine running, it will automatically shut off.

This vehicle is equipped with a Honda SMART Key system. Always keep Honda SMART Key on you when you ride the vehicle.  **P.35**

If the engine of this vehicle is stopped while the ignition switch is in the **I** (On) position, authentication will be disabled after a certain amount of time or if you leave the authentication range. Restart the engine by performing the start procedure after pressing the ignition switch again.

- ▶ If the engine of this vehicle is stopped by the Idling Stop System, authentication will not be disabled.
- ▶ If the Honda SMART Key is within the authentication range and authentication is disabled after a certain amount of time, the Honda SMART Key indicator will notify you by flashing rapidly for a certain amount of time.

NOTICE

- If the engine does not start within 5 seconds, turn the ignition switch to the **O** (Off) position and wait 10 seconds before trying to start the engine again to recover battery voltage.
- Extended fast idling and reving the engine can damage the engine, and the exhaust system.
- The engine will not start if the throttle is fully open.
- If the vehicle is over-turned, you must first turn the ignition switch to the **O** (Off) position and then inspect the vehicle carefully.

- 1 Place the vehicle on its centre stand.
- 2 Turn the ignition switch to the **I** (On) position.

▶ To unlock the ignition switch. **→ P.38**

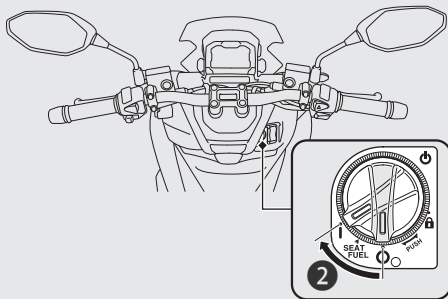

- 3 Squeeze the rear brake lever.
▶ The starter motor will only work when the rear brake lever is squeezed and the side stand is up.
- 4 With the throttle completely closed, press the start button.

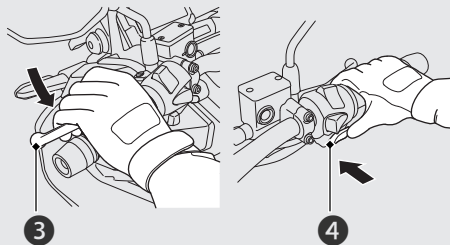

Starting the Engine *(Continued)*

If you cannot start the engine:

- ① Place the vehicle on its centre stand and squeeze the rear brake lever.
- ② Open the throttle slightly (about 3 mm, without freeplay), press the start button.

About 3 mm, without freeplay

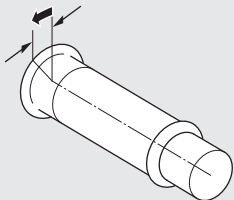

If the engine does not start:

- ① Open the throttle fully and press the start button for 5 seconds.
- ② Repeat the normal starting procedure.
- ③ If the engine starts, open the throttle slightly if idling is unstable.
- ④ If the engine does not start, wait 10 seconds before trying steps ① & ② again.

If Engine Will Not Start ➔ P.107

Riding

Starting the Vehicle

- 1 Push the vehicle forward off the centre stand.
 - ▶ Squeeze the rear brake lever.
 - ▶ Keep throttle closed.

Make sure the side stand and centre stand are up.

- 2 Get on the vehicle.
 - ▶ Mount the vehicle from the left side, keeping at least one foot on the ground.
- 3 Release the brake lever.

- 4 Acceleration and deceleration
To accelerate: Open the throttle slowly.
To decelerate: Close the throttle.

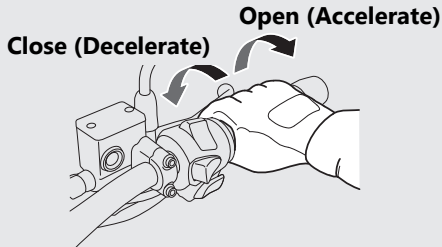

Riding *(Continued)*

Braking

Close the throttle and apply the front and rear brake levers together.

NOTICE

To prevent clutch damage, do not use the throttle to keep the vehicle stopped at up hill.

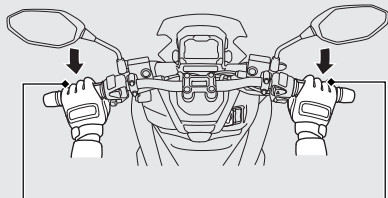

Rear brake lever

Front brake lever

Emergency Stop Signal

ADV150A

Emergency stop signal activates when you brake hard while driving at 50 km/h (31 mph) or above to alert drivers behind you about sudden braking by rapidly flashing both turn signal lights. This may help to alert drivers behind you to take appropriate means to avoid a possible collision with your vehicle.

The emergency stop signal stops operating when:

- You release the brake lever and pedal.
- The ABS is deactivated.
- Your vehicle's decelerating speed becomes moderate.
- You press the hazard switch.

When the system activates:

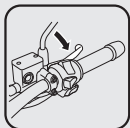

1 Hard braking

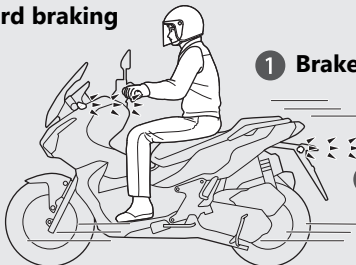

1 Brakelight come on

2 Both turn signals flash

2 Both turn signal indicators blink

Emergency Stop Signal *(Continued)*

- ▶ The emergency stop signal is not a system that can prevent a possible rear-end collision caused by your hard braking. It is always recommended to avoid hard braking unless it is absolutely necessary.
- ▶ The emergency stop signal does not activate with the hazard switch pressed in.
- ▶ If the ABS stops working for a certain period during braking, the emergency stop signal may not activate at all.

Refuelling

Fuel type: Unleaded petrol only

Fuel octane number: Your vehicle is designed to use Research Octane Number (RON) 88 or higher.

Tank capacity: 8.0 L (2.11 US gal, 1.76 Imp gal)

Refuelling and Fuel Guidelines ➔ P.10

Opening the Fuel Fill Cap

- 1 Turn the ignition switch to the position of SEAT FUEL.
 - ▶ To unlock the ignition switch ➔ P.38
- 2 Push the FUEL side of the fuel lid and seat opener switch.
 - ▶ The fuel lid opens.

Fuel lid

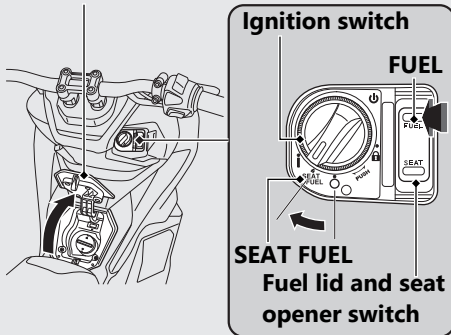

Refuelling *(Continued)*

- ③ Turn the fuel fill cap counterclockwise and remove the fuel fill cap.

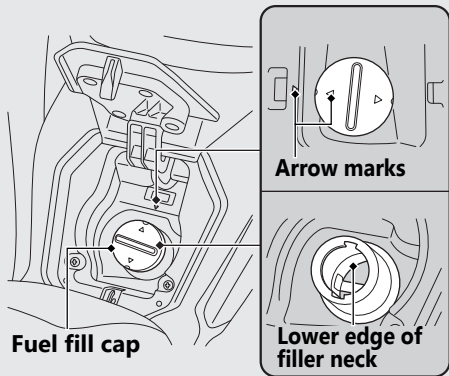

Do not fill with fuel above the lower edge of the filler neck.

Closing the Fuel Fill Cap

- ① Install and tighten the fuel fill cap firmly by turning it clockwise.
- ▶ Make sure that the arrow marks on the fuel fill cap and fuel tank are aligned.
- ② Close the fuel lid until it locks.
- ▶ Make sure that the fuel lid is closed securely.

⚠ WARNING

Petrol is highly flammable and explosive. You can be burned or seriously injured when handling fuel.

- Stop the engine, and keep heat, sparks, and flame away.
- Handle fuel only outdoors.
- Wipe up spills immediately.

Accessory Socket

The accessory socket is located in the front box. ➔P.67

Use accessory devices at your own risk. In no event shall Honda be liable for any damages to your accessory device when in use.

Open the cover to access the socket.

Rated capacity is

12W (12V, 1A).

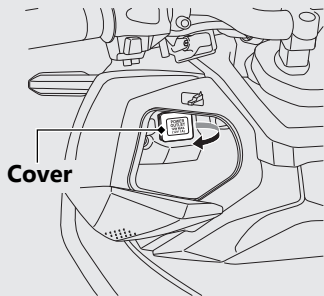

- ▶ To prevent the battery from becoming weak (or dead), keep the engine running while drawing current from the socket.
- ▶ Set the headlight on low beam while the socket is in use. The battery may run down or cause damage to the socket.
- ▶ To prevent entry of foreign matter into the socket, be sure to close the cover when the socket is not used.

NOTICE

- Using any heat-generating accessory or improperly rated accessory can damage the socket.
- Do not use the socket in wet conditions, when or while washing or any other wet conditions as these will damage the socket.

Storage Equipment

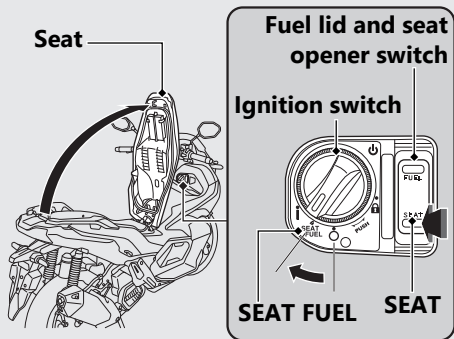

Seat Open

- 1 Turn the handlebar pointed straight ahead.
- 2 Turn the ignition switch to the position of SEAT FUEL.
 - ▶ To unlock the ignition switch ➔ **P.38**
- 3 Push the SEAT side of the fuel lid and seat opener switch.
- 4 Open the seat.

Seat Close

Close and push down on the rear of the seat until it locks. Make sure that the seat is locked securely by pulling it up lightly. Take care not to lock your key in the compartment under the seat.

Helmet Holder

The helmet holder is located under the seat. A helmet set wire is in the tool kit.

- ▶ Use the helmet holder only when parked.

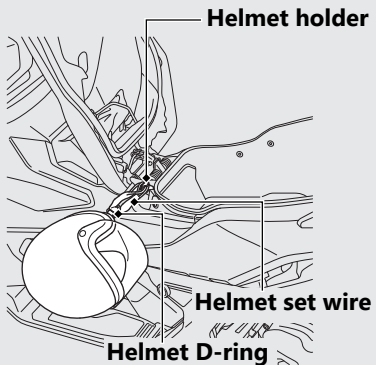

⚠WARNING

Riding with a helmet attached to the holder can interfere with your ability to safely operate the vehicle and could lead to a crash in which you can be seriously hurt or killed.

Use the helmet holder only while parked. Do not ride with a helmet secured by the holder.

Storage Equipment *(Continued)*

A helmet can be stored in the centre compartment.

Set in the front of the helmet forward.

- ▶ Some helmets may not fit in the compartment due to their size or design.

Helmet

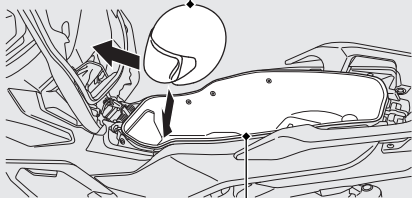

Centre compartment

Centre Compartment

Never exceed the maximum weight limit.

Maximum Weight: 10 kg (22 lb)

- ▶ Do not store any items that are flammable or susceptible to heat damage.
- ▶ Do not store valuables or fragile articles.

Tool Kit/Document Bag

The tool kit and document bag are located underside of the seat by the rubber strap.

Document bag

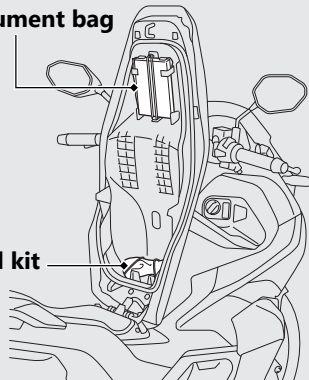

Tool kit

Front Box

Open

Push the front box lid, then open the front box lid.

Close

Close the front box lid by pressing the front box lid.

The maximum allowable load in the front box shall be no more than

IN 1.0 kg (2.2 lb)

PH, II PH 1.0 kg (2.0 lb)

Make sure that the front box lid is closed securely.

- ▶ Do not store valuables or fragile articles.

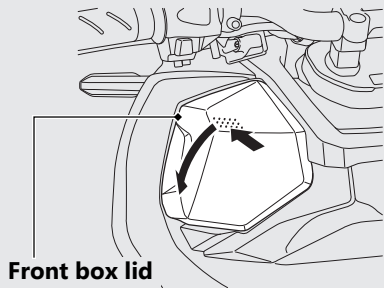

Maintenance

Please read “Importance of Maintenance” and “Maintenance Fundamentals” carefully before attempting any maintenance. Refer to “Specifications” for service data.

Importance of Maintenance	P. 69	Throttle	P. 100
Maintenance Schedule	P. 70	Crankcase Breather	P. 101
Maintenance Fundamentals	P. 73	Other Adjustments	P. 102
Tool	P. 83	Adjusting the Headlight Aim	P. 102
Removing & Installing Body Components ..	P. 84	Adjusting the Windscreen Height	P. 103
Battery	P. 84	Other Replacement	P. 104
Battery Cover	P. 85	Replacing the Honda SMART Key Battery ..	P. 104
Clip	P. 86		
Front Lid	P. 87		
Spark Plug	P. 88		
Engine Oil	P. 91		
Coolant	P. 95		
Brakes	P. 97		
Side Stand	P. 99		

Importance of Maintenance

Importance of Maintenance

Keeping your vehicle well-maintained is absolutely essential to your safety and to protect your investment, obtain maximum performance, avoid breakdowns, and reduce air pollution. Maintenance is the owner's responsibility. Be sure to inspect your vehicle before each ride, and perform the periodic checks specified in the Maintenance Schedule.

➔ P. 70

⚠ WARNING

Improperly maintaining your vehicle or failing to correct a problem before you ride can cause a crash in which you can be seriously hurt or killed.

Always follow the inspection and maintenance recommendations and schedules in this owner's manual.

Maintenance Safety

Always read the maintenance instructions before you begin each task, and make sure that you have the tools, parts, and skills required. We cannot warn you of every conceivable hazard that can arise in performing maintenance. Only you can decide whether or not you should perform a given task.

Follow these guidelines when performing maintenance.

- Stop the engine and turn the ignition switch to the **○** (Off) position.
- Place your vehicle on a firm, level surface using the side stand, centre stand or a maintenance stand to provide support.
- Allow the engine, muffler, brakes, and other high-temperature parts to cool before servicing as you can get burned.
- Run the engine only when instructed, and do so in a well-ventilated area.

Maintenance Schedule

The maintenance schedule specifies the maintenance requirements necessary to ensure safe, dependable performance, and proper emission control.

Maintenance work should be performed in accordance with Honda's standards and specifications by properly trained and equipped technicians. Your dealer meets all of these requirements. Keep an accurate record of maintenance to help ensure that your vehicle is properly maintained.

Make sure that whomever performs the maintenance completes this record.

All scheduled maintenance is considered a normal owner operating cost and will be charged to you by your dealer. Retain all receipts. If you sell the vehicle, these receipts should be transferred with the vehicle to the new owner.

Honda recommends that your dealer should road test your vehicle after each periodic maintenance is carried out.

Maintenance Schedule

Items		Pre-ride Check P. 73	Frequency *1								Annual Check	Regular Replace	Refer to page
			× 1,000 km	1	6	12	18	24	30	36			
			× 1,000 mi	0.6	4	8	12	16	20	24			
Fuel Line	🔧			I	I	I	I	I	I	I	I		-
Fuel Level		I											-
Throttle Operation	🔧	I		I	I	I	I	I	I	I	I		100
Air Cleaner *2	🔧					R				R			82
Crankcase Breather *3				C	C	C	C	C	C	C			101
Spark Plug				I	R	I	R	I	R				88
Valve Clearance	🔧			I	I	I	I	I	I				-
Engine Oil		I	R	R	R	R	R	R	R	R	R		91
Engine Oil Strainer Screen					C			C		C			92
Engine Idle Speed	🔧		I	I	I	I	I	I	I	I	I		-
Radiator Coolant *4		I			I		I		I	I	I	3 Years	95
Cooling System	🔧				I		I		I	I	I		-

Maintenance Level

- 🔧 : Intermediate. We recommend service by your dealer, unless you have the necessary tools and are mechanically skilled.
Procedures are provided in an official Honda Shop Manual.
- 🔧 : Technical. In the interest of safety, have your vehicle serviced by your dealer.

Maintenance Legend

- I : Inspect (clean, adjust, lubricate, or replace, if necessary)
R : Replace
C : Clean

Maintenance Schedule

Items		Pre-ride Check P. 73	Frequency *1								Annual Check	Regular Replace	Refer to page	
			× 1,000 km	1	6	12	18	24	30	36				
			× 1,000 mi	0.6	4	8	12	16	20	24				
Drive Belt					I			R		I				-
Final Drive Oil *4													2 Years	-
Battery				I	I	I	I	I	I	I	I			84
Brake Fluid *4		I		I	I	I	I	I	I	I	I		2 Years	97
Brake Pads Wear		I		I	I	I	I	I	I	I	I			98
Brake System			I	I	I	I	I	I	I	I	I			97
Headlight Aim				I	I	I	I	I	I	I	I			102
Lights/Horn		I												-
Clutch Shoes Wear					I			I		I				-
Side Stand		I		I	I	I	I	I	I	I	I			99
Suspension				I	I	I	I	I	I	I	I			-
Nuts, Bolts, Fasteners			I		I			I		I	I			-
Wheels/Tyres		I		I	I	I	I	I	I	I	I			79
Steering Head Bearings					I			I		I	I			-

Notes:

*1 : At higher odometer reading, repeat at the frequency interval established here.

*2 : Service more frequently when riding in unusually wet or dusty areas.

*3 : Service more frequently when riding in rain or at full throttle.

*4 : Replacement requires mechanical skill.

Pre-ride Inspection

To ensure safety, it is your responsibility to perform a pre-ride inspection and make sure that any problem you find is corrected. A pre-ride inspection is a must, not only for safety, but because having a breakdown, or even a flat tyre, can be a major inconvenience.

Check the following items before you get on your vehicle:

- Fuel level - Fill fuel tank when necessary.
➔ P. 61
 - Throttle - Check for smooth opening and full closing in all steering positions. ➔ P. 100
 - Engine oil level - Add engine oil if necessary. Check for leaks. ➔ P. 91
 - Coolant level - Add coolant if required. Check for leaks. ➔ P. 95
- Brakes - Check operation; Front and Rear: check brake fluid level and pads wear. ➔ P. 97, ➔ P. 98
 - Lights and horn - Check that lights, indicators and horn function properly.
 - Side stand ignition cut-off system - Check for proper function. ➔ P. 99
 - Wheels and tyres - Check condition, air pressure and adjust if necessary. ➔ P. 79

Replacing Parts

Always use Honda Genuine Parts or their equivalents to ensure reliability and safety.

⚠ WARNING

Installing non-Honda parts may make your vehicle unsafe and cause a crash in which you can be seriously hurt or killed.

Always use Honda Genuine Parts or equivalents that have been designed and approved for your vehicle.

Battery

Your vehicle has a maintenance-free type battery. You do not have to check the battery electrolyte level or add distilled water. Clean the battery terminals if they become dirty or corroded.

Do not remove the battery cap seals. There is no need to remove the cap when charging.

NOTICE

Your battery is a maintenance-free type and can be permanently damaged if the cap strip is removed.



This symbol on the battery means that this product must not be treated as household waste.

NOTICE

An improperly disposed of battery can be harmful to the environment and human health. Always confirm local regulations for proper battery disposal instruction.

| What to do in an emergency

If any of the following occur, immediately see your doctor.

- Electrolyte splashes into your eyes:
 - ▶ Wash your eyes repeatedly with cool water for at least 15 minutes. Using water under pressure can damage your eyes.
- Electrolyte splashes onto your skin:
 - ▶ Remove affected clothing and wash your skin thoroughly using water.
- Electrolyte splashes into your mouth:
 - ▶ Rinse mouth thoroughly with water, and do not swallow.

⚠ WARNING

The battery gives off explosive hydrogen gas during normal operation.

A spark or flame can cause the battery to explode with enough force to kill or seriously hurt you.

Wear protective clothing and a face shield, or have a skilled mechanic do the battery servicing.

| Cleaning the Battery Terminals

1. Remove the battery. ➤ P. 84
2. If the terminals are starting to corrode and are coated with a white substance, wash with warm water and wipe clean.

Maintenance Fundamentals

- If the terminals are heavily corroded, clean and polish the terminals with a wire brush or sandpaper. Wear safety glasses.

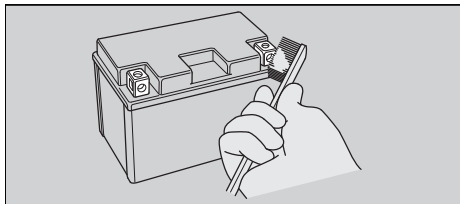

- After cleaning, reinstall the battery.

The battery has a limited life span. Consult your dealer about when you should replace the battery. Always replace the battery with another maintenance-free battery of the same type.

NOTICE

Installing non-Honda electrical accessories can overload the electrical system, discharging the battery and possibly damaging the system.

Fuses

Fuses protect the electrical circuits on your vehicle. If something electrical on your vehicle stops working, check for and replace any blown fuses. 📄 P. 126

Inspecting and Replacing Fuses

Turn the ignition switch to the **○** (Off) position to remove and inspect fuses. If a fuse is blown, replace with a fuse of the same rating. For fuse ratings, see "Specifications." 📄 P. 145

Blown fuse



NOTICE

Replacing a fuse with one that has a higher rating greatly increases the chance of damage to the electrical system.

If a fuse fails repeatedly, you likely have an electrical fault. Have your vehicle inspected by your dealer.

Engine Oil

Engine oil consumption varies and oil quality deteriorates according to riding conditions and time elapsed.

Check the engine oil level regularly, and add the recommended engine oil if necessary. Dirty oil or old oil should be changed as soon as possible.

Selecting the Engine Oil

For recommended engine oil, see “Specifications.” P. 144

If you use non-Honda engine oil, check the label to make sure that the oil satisfies all of the following standards:

- JASO T 903 standard^{*1}: MB
- SAE standard^{*2}: 10W-30
- API classification^{*3}: SG or higher

- ^{*1}. The JASO T 903 standard is an index for engine oils for 4-stroke motorcycle engines. There are two classes: MA and MB. For example, the following label shows the MB classification.

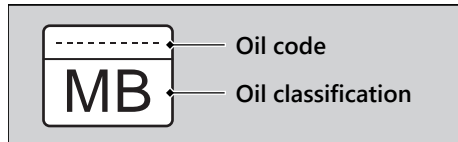

- ^{*2}. The SAE standard grades oils by their viscosity.
- ^{*3}. The API classification specifies the quality and performance rating of engine oils. Use SG or higher oils, excluding oils marked as “Energy Conserving” or “Resource Conserving” on the circular API service symbol.

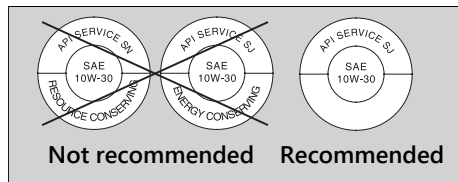

Maintenance Fundamentals

Brake Fluid

Do not add or replace brake fluid, except in an emergency. Use only fresh brake fluid from a sealed container. If you do add fluid, have the brake system serviced by your dealer as soon as possible.

NOTICE

Brake fluid can damage plastic and painted surfaces.
Wipe up spills immediately and wash thoroughly.

Recommended brake fluid:

Honda DOT 3 or DOT 4 Brake Fluid or equivalent

Recommended Coolant

Use only genuine HONDA PRE-MIX COOLANT without diluting with water. Genuine HONDA PRE-MIX COOLANT is excellent at preventing corrosion and overheating.

The coolant should be inspected and replaced properly by following the maintenance schedule. ➤ P. 70

NOTICE

Using coolant not specified for aluminium engines or tap/mineral water can cause corrosion.

Crankcase Breathers

Service more frequently when riding in rain, at full throttle, or after the vehicle is washed or overturned. Service if the deposit level can be seen in the transparent section of the drain tube.

If the drain tube overflows, the air filter may become contaminated with engine oil causing poor engine performance. ➤ P. 101

Tyres (Inspecting/Replacing)

Checking the Air Pressure

Visually inspect your tyres and use an air pressure gauge to measure the air pressure at least once a month or any time you think the tyres look low. Always check air pressure when your tyres are cold.

Inspecting for Damage

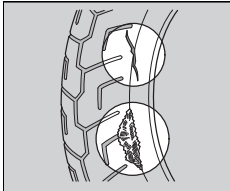

Inspect the tyres for cuts, slits, or cracks that exposes fabric or cords, or nails or other foreign objects embedded in the side of the tyre or the tread.

Also inspect for any unusual bumps or bulges in the side walls of the tyres.

Inspecting for Abnormal Wear

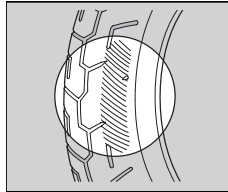

Inspect the tyres for signs of abnormal wear on the contact surface.

Inspecting Tread Depth

Inspect the tread wear indicators. If they become visible, replace the tyres immediately. For safe riding, you should replace the tyres when the minimum tread depth is reached.

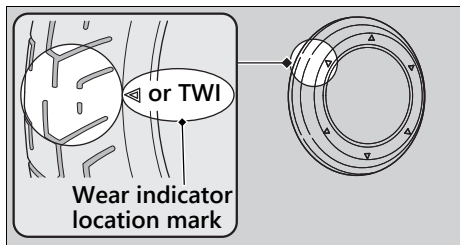

⚠️ WARNING

Riding on tyres that are excessively worn or improperly inflated can cause a crash in which you can be seriously hurt or killed.

Follow all instructions in this owner's manual regarding tyre inflation and maintenance.

Have your tyres replaced by your dealer. For recommended tyres, air pressure and minimum tread depth, see “Specifications.”

➤ P. 144

Follow these guidelines whenever you replace tyres.

- Use the recommended tyres or equivalents of the same size, construction, speed rating, and load range.
- Do not install a tube inside a tubeless tyre on this vehicle. Excessive heat build-up can cause the tube to burst.
- Use only tubeless tyres on this vehicle. The rims are designed for tubeless tyres, and during hard acceleration or braking, a tube-type tyre could slip on the rim and cause the tyre to rapidly deflate.

WARNING

Installing improper tyres on your vehicle can adversely affect handling and stability, and can cause a crash in which you can be seriously hurt or killed.

Always use the size and type of tyres recommended in this owner's manual.

Maintenance Fundamentals

Air Cleaner

This vehicle is equipped with a viscous type air cleaner element.

Air blow cleaning or any other cleaning can degrade the viscous element performance and cause the intake of dust.

Do not perform the maintenance. Should be serviced by your dealer.

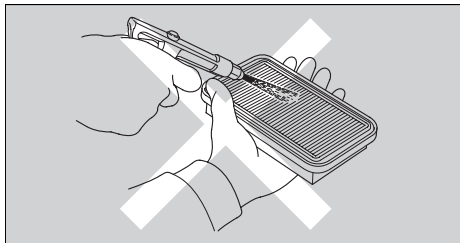

Tool

The tool kit is stored underside of the seat.

➔ P. 66

You can perform some roadside repairs, minor adjustments and parts replacement with the provided tools.

- Spark plug wrench
- 10 × 14 mm Open end wrench
- Standard/Phillips screwdriver
- Screwdriver handle
- Helmet set wire
- EM mode coupler

Battery

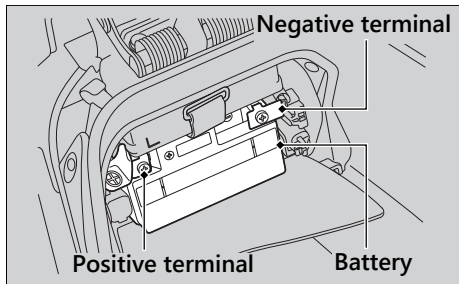
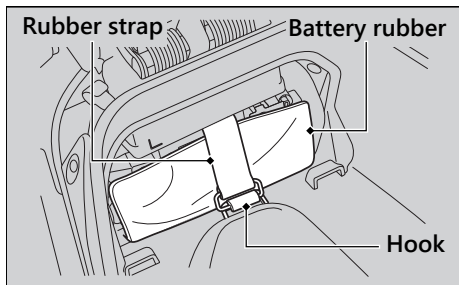

Removal

Make sure the ignition switch is in the O (Off) position.

1. Remove the battery cover. ➤ P. 85
2. Remove the rubber strap from the hook then pull the battery rubber down.
3. Disconnect the negative \ominus terminal from the battery.
4. Disconnect the positive \oplus terminal from the battery.
5. Remove the battery taking care not to drop the terminal nuts.

Installation

Install the parts in the reverse order of removal. Always connect the positive ⊕ terminal first. Make sure that bolts and nuts are tight.

- Make sure the battery rubber is set in the correct position as shown.

Make sure the clock information is correct after the battery is reconnected. ► P. 24
The anti-theft alarm system will be deactivated if the battery is disconnected. The system will remain off when the battery is reconnected.

To activate the system, turn the ignition switch to the **I** (On) position once.

For proper handling of the battery, see "Maintenance Fundamentals." ► P. 74
"Battery Goes Dead." ► P. 124

Battery Cover

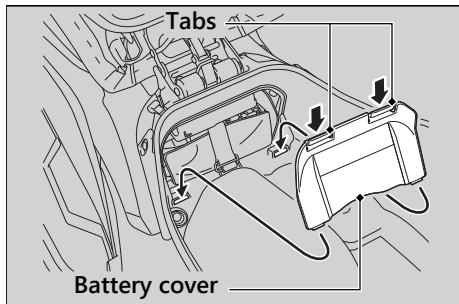

Removal

1. Open the seat. ► P. 64
2. Press the tabs and remove the battery cover.

Installation

Install the parts in the reverse order of removal.

Clip

Removal

1. Press down on the centre pin to release the lock.
2. Pull the clip out of the hole.



Installation

1. Push the bottom of the centre pin.



2. Insert the clip into the hole.
3. Press down on the centre pin to lock the clip.

Front Lid

Removal

Pull out the front lid backward while pushing the side of the front lid.

Installation

Install the part in the reverse order of removal.

Make sure that all tabs are installed securely in position.

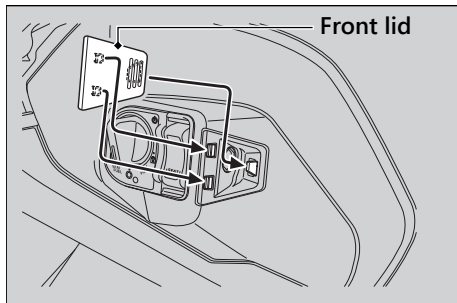
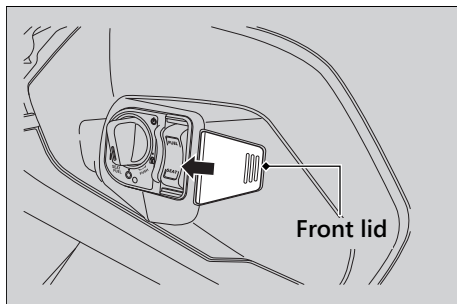

Checking Spark Plug

For the recommended spark plug, see "Specifications." ➤ P. 144

Use only the recommended type of spark plug in the recommended heat range.

NOTICE

Using a spark plug with an improper heat range can cause engine damage.

1. Place your vehicle on the side stand on a level surface.
2. Pull the floor mat off.
3. Remove the plug maintenance lid by removing the clip (➤ P. 86) and release the tabs from slots.

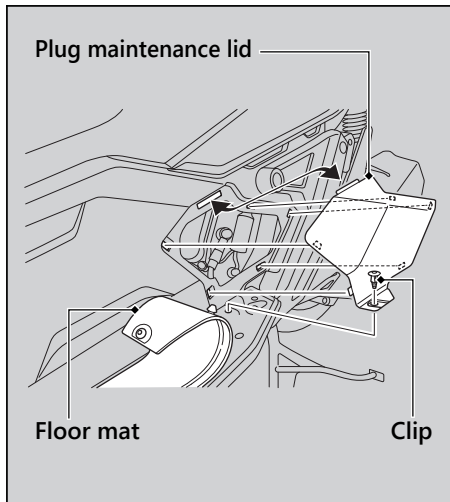

4. Disconnect the spark plug cap from the spark plug.
5. Clean any dirt from around the spark plug base.
6. Remove the spark plug using provided spark plug wrench. ▣ P. 83

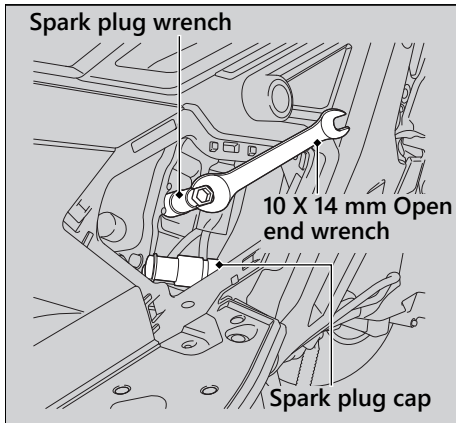

7. Inspect the electrodes and centre porcelain for deposits, erosion or carbon fouling.
 - If the erosion or deposit is heavy, replace the plug.
 - Clean a carbon or wet-fouled plug with a plug cleaner, otherwise use a wire brush.
8. Check the spark plug gap using a wire-type feeler gauge.
 - If adjustment is necessary, bend the side electrode carefully.

The gap should be:

0.8 - 0.9 mm (0.03 - 0.04 in)

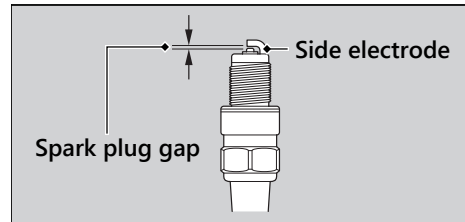

Spark Plug ► Checking Spark Plug

9. Make sure the plug washer is in good condition.
10. Install the spark plug. With the plug washer attached, thread the spark plug in by hand to prevent cross-threading.
11. Tighten the spark plug:
 - Installing a new plug, tighten it twice to prevent loosening:
 - a) First, tighten the plug:
1/2 turn after it seats.
 - b) Then loosen the plug.
 - c) Next, tighten the plug again:
1/8 turn after it seats.

NOTICE

An improperly tightened spark plug can damage the engine. If a plug is too loose, a piston may be damaged. If a plug is too tight, the threads may be damaged.

12. Install the parts in the reverse order of removal.
 - When reinstalling the spark plug cap, take care to avoid pinching any cables or wires.

Checking the Engine Oil

Check the engine oil with the Idling Stop switch at IDLING.

1. If the engine is cold, idle the engine for 3 to 5 minutes.
2. Turn the ignition switch to the **○** (Off) position and wait for 2 to 3 minutes.
3. Place your vehicle on its centre stand on a firm, level surface.
4. Remove the oil fill cap/dipstick and wipe it clean.
5. Insert the oil fill cap/dipstick until it seats, but don't screw it in.
6. Check that the oil level is between the upper level and lower level marks on the oil fill cap/dipstick.
7. Securely install the oil fill cap/dipstick.

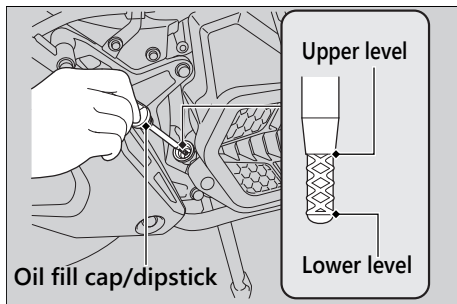

Adding Engine Oil

If the engine oil is below or near the lower level mark, add the recommended engine oil.

► P. 77, ► P. 144

1. Remove the oil fill cap/dipstick. Add the recommended oil until it reaches the upper level mark.
 - Place your vehicle on its centre stand on a firm, level surface when checking the oil level.
 - Do not overfill above the upper level mark.
 - Make sure no foreign objects enter the oil filler opening.
 - Wipe up any spills immediately.
2. Securely reinstall the oil fill cap/dipstick.

NOTICE

Overfilling with oil or operating with insufficient oil can cause damage to your engine. Do not mix different brands and grades of oil.

For the recommended oil and oil selection guidelines, see "Maintenance Fundamentals."

► P. 77

Changing Engine Oil, Cleaning Strainer Screen

Changing the oil and cleaning the strainer screen requires special tools. We recommend that you have your vehicle serviced by your dealer.

Change the engine oil with the Idling Stop switch at IDLING.

1. If the engine is cold, idle the engine for 3 to 5 minutes.
2. Turn the ignition switch to the **O** (Off) position and wait for 2 to 3 minutes.
3. Place your vehicle on its centre stand on a firm, level surface.

4. Place a drain pan under the drain bolt and oil plug.
5. Remove the oil fill cap/dipstick, drain bolt and sealing washer to drain the oil.
6. Remove the oil plug, O-ring, spring and oil strainer screen and let the remaining oil drain out.
 - Discard the oil at an approved recycling centre.
7. Clean the oil strainer screen.
8. Check that the oil strainer screen and sealing rubber are in good condition.
9. Replace the O-ring and apply a thin coat of engine oil to the new O-ring before installing it.
10. Install the oil strainer screen, spring and oil plug and tighten.

Torque: 20 N·m (2.0 kgf·m, 15 lbf·ft)

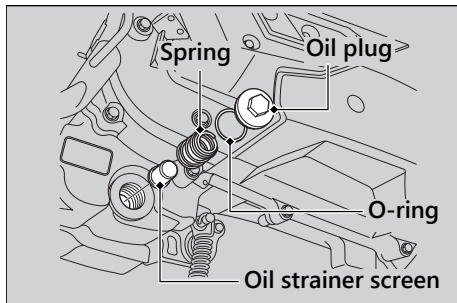
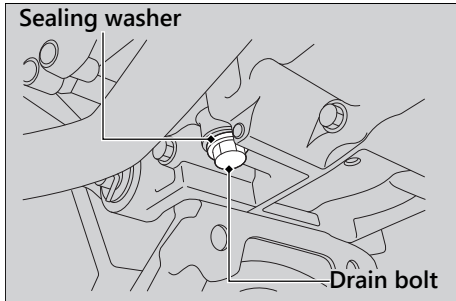

Engine Oil ► Changing Engine Oil, Cleaning Strainer Screen

11. Install a new sealing washer onto the drain bolt. Tighten the drain bolt.

Torque: 24 N·m (2.4 kgf·m, 18 lbf·ft)

12. Fill the crankcase with the recommended oil (► P. 77, ► P. 144) and install the oil fill cap/dipstick.

Required oil

When changing oil & cleaning the strainer screen:

0.8 L (0.8 US qt, 0.7 Imp qt)

When changing oil only:

0.8 L (0.8 US qt, 0.7 Imp qt)

13. Check the oil level. ► P. 91
14. Check that there are no oil leaks.

Checking the Coolant

Check the coolant level in the reserve tank while the engine is cold.

1. Place your vehicle on its centre stand on a firm, level surface.
2. Check that the coolant level is between the UPPER level and LOWER level marks on the reserve tank.

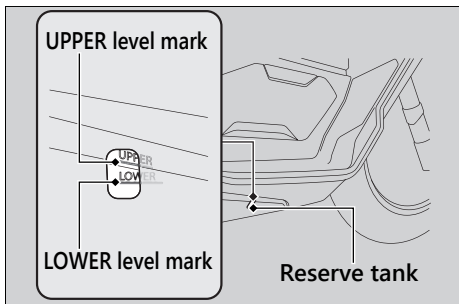

If the coolant level is dropping noticeably or the reserve tank is empty, you likely have a serious leak. Have your vehicle inspected by your dealer.

Adding Coolant

If the coolant level is below the LOWER level mark, add the recommended coolant (P. 78) until the level reaches the UPPER level mark.

Add fluid only from the reserve tank cap and do not remove the radiator cap.

1. Pull the floor mat off.
2. Remove the reserve tank lid by inserting a flat head screwdriver covered with a protective cloth into the slit on the right side floor.

Coolant ► Changing Coolant

3. Remove the reserve tank cap and add fluid while monitoring the coolant level.
 - Do not overfill above the UPPER level mark.
 - Make sure no foreign objects enter the reserve tank opening.
4. Securely reinstall the reserve tank cap.
5. Install the reserve tank lid and floor mat.

⚠ WARNING

Removing the radiator cap while the engine is hot can cause the coolant to spray out, potentially scalding you.

Always let the engine and radiator cool down before removing the radiator cap.

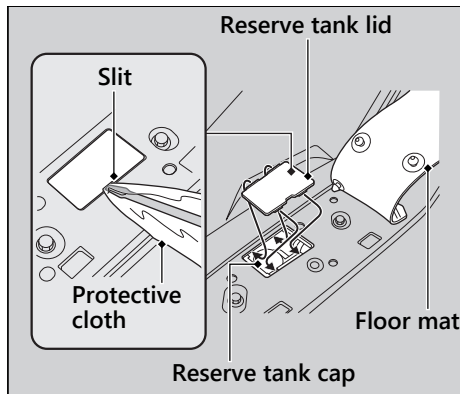

Changing Coolant

Have your dealer change the coolant unless you have the proper tools and are mechanically qualified.

Checking Brake Fluid

1. Place your vehicle in an upright position on a firm, level surface.
2. Check that the brake fluid reservoir is horizontal and that the fluid level is above the LOWER level mark.

If the brake fluid level in either reservoir is below the LOWER level mark or both the brake levers freeplay becomes excessive, inspect the brake pads for wear.

If the brake pads are not worn, you most likely have a leak. Have your vehicle inspected by your dealer.

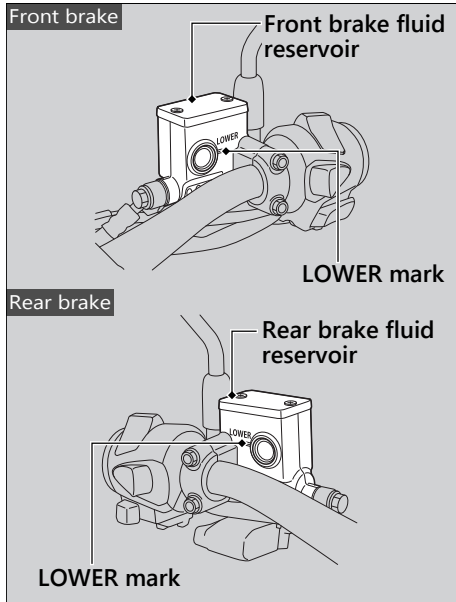

Inspecting the Brake Pads

Check the condition of the brake pad wear indicators.

Front

The pads need to be replaced if a brake pad is:

ADV150 worn to the bottom of the indicator.

ADV150A worn to the indicator.

Rear

The pads need to be replaced if a brake pad is worn to the indicator.

1. **Front** Inspect the brake pads from in front of the brake caliper.
2. **Rear** Inspect the brake pads from the rear right of the vehicle.

If necessary have the pads replaced by your dealer.

Always replace both left and right brake pads at the same time.

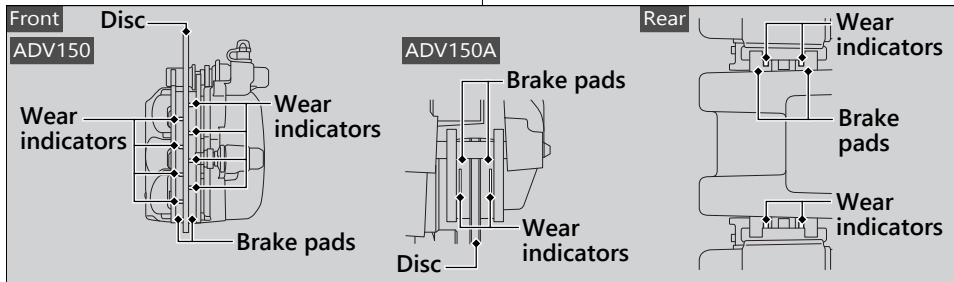

Checking the Side Stand

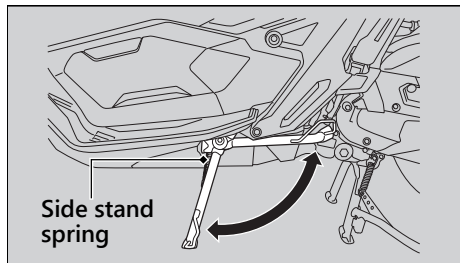

1. Place your vehicle on its centre stand on a firm, level surface.
2. Check that the side stand operates smoothly. If the side stand is stiff or squeaky, clean the pivot area and lubricate the pivot bolt with clean grease.
3. Check the spring for damage or loss of tension.
4. Sit on the vehicle and raise the side stand.
5. Start the engine.
6. Lower the side stand all the way. The engine should stop as you lower the side stand. If the engine doesn't stop, have your vehicle inspected by your dealer.

Checking the Throttle

With the engine off, check that the throttle rotates smoothly from fully closed to fully open in all steering positions and throttle freeplay is correct. If the throttle does not move smoothly, close automatically, or if the cable is damaged, have the vehicle inspected by your dealer.

Freeplay at the throttle grip flange:

2 - 6 mm (0.1 - 0.2 in)

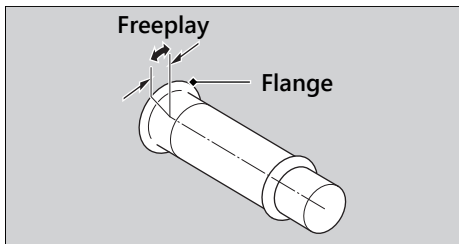

Cleaning the Crankcase Breather

1. Place a suitable container to receive deposits.
2. Remove the crankcase breather tube plug from the tube
3. Remove the crankcase breather plug from the air cleaner case.
4. Drain deposits into a suitable container.
5. Install the crankcase breather tube plug.
6. Install the crankcase breather tube.

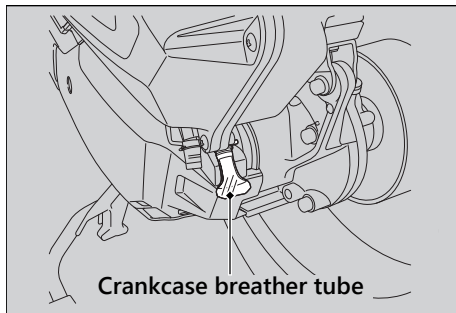
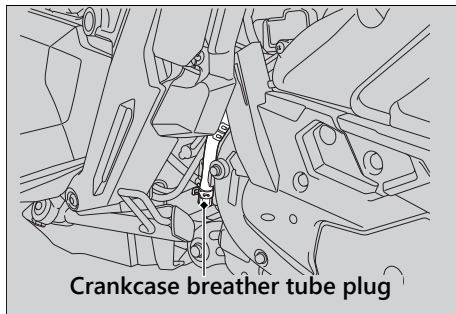

Adjusting the Headlight Aim

You can adjust vertical aim of the headlights for proper alignment. Turn the pinion in or out as necessary using a Phillips screwdriver provided in the tool kit (▶ P. 83).

Obey local laws and regulations.

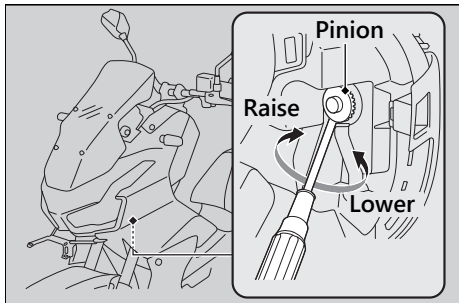

Adjusting the Windscreen Height

The windscreen can be adjusted to 2 positions.

► Do not adjust the windscreen while riding.

Pull the windscreen adjusting knobs and move the windscreen up or down.

► Make sure the windscreen is locked securely by slightly moving the windscreen up or down.

If the windscreen does not move smoothly, have your vehicle inspected by your dealer.

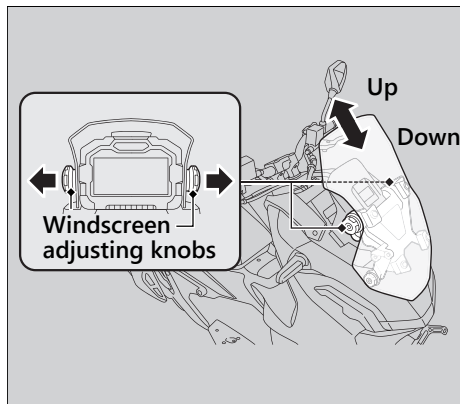

Replacing the Honda SMART Key Battery

If the Honda SMART Key indicator flashes 5 times when the ignition switch is turned **I** (On), or the operating range becomes unstable, replace the battery as soon as possible.

We recommend to see your dealer for this service.

Battery type: CR2032

1. Remove the upper case by inserting a coin or a flat head screwdriver covered with a protective cloth into the slit.
 - ▶ Wrap a coin or a screwdriver with a protective cloth to prevent scratching the Honda SMART Key.
 - ▶ Do not touch the circuit or terminal. This may cause problems.
 - ▶ Be careful to avoid scratching the waterproof covering or allowing dust to enter.
 - ▶ Do not forcibly dismantle the Honda SMART Key body.

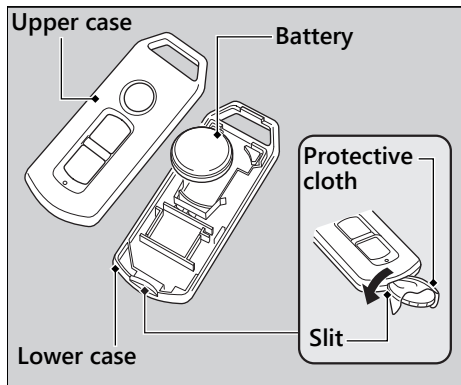

2. Replace the old battery with a new battery with the negative \ominus side facing up.
3. Snap the two halves of the remote transmitter back together.
 - Make sure that upper and lower cases are set in the right position.

⚠ WARNING

Chemical Burn Hazard: do not swallow battery.

If swallowed, the battery can cause severe internal burns and even death.

- Keep battery away from children and battery compartment securely closed.
- If the battery compartment does not close securely, stop using the product and keep it away from children.
- Immediately seek medical attention if a child may have swallowed battery.

Troubleshooting

Engine Will Not Start	P. 107	Engine Does Not Start Even If the Throttle is Opened	P. 116
Overheating (High coolant temperature indicator is on)	P. 108	When the Honda SMART Key System Does Not Operate Properly	P. 117
Warning Indicators On or Flashing	P. 109	Unlock the Seat in an Emergency	P. 119
PGM-FI (Programmed Fuel Injection)		Unlock the Ignition Switch in an Emergency	P. 120
Malfunction Indicator Lamp (MIL).....	P. 109	Tyre Puncture	P. 123
ABS (Anti-lock Brake System) Indicator	P. 110	Electrical Trouble	P. 124
Honda SMART Key Indicator.....	P. 111	Battery Goes Dead.....	P. 124
Other Warning Indications	P. 113	Burned-out Light Bulb	P. 124
Fuel Gauge Failure Indication.....	P. 113	Blown Fuse.....	P. 126
When the Idling Stop System Does Not Operate Properly	P. 114	Unstable Engine Operation Occurs Intermittently	P. 127
Idling Stop Indicator Does Not Come On ..	P. 114		
Engine is Not Stopped by the Idling Stop System			
While the Idling Stop Indicator is On.....	P. 115		

Starter Motor Operates But Engine Does Not Start

Check the following items:

- Check the correct engine starting sequence. ➤ P. 54
- Check that there is petrol in the fuel tank.
- Check if the PGM-FI malfunction indicator lamp (MIL) is on.
 - ▶ If the indicator lamp is on, contact your dealer as soon as possible.

Starter Motor Does Not Operate

Check the following items:

- Check the correct engine starting sequence. ➤ P. 54
- Check for a blown fuse. ➤ P. 126
- Check for a loose battery connection (➤ P. 84) or battery terminal corrosion (➤ P. 74).
- Check the condition of the battery.
 - P. 124
- Check the Honda SMART Key indicator.
 - ▶ If it is flashing, start the engine by the normal procedure after pressing the ignition switch again. ➤ P. 54

If the problem continues, have your vehicle inspected by your dealer.

Overheating (High coolant temperature indicator is on)





The engine is overheating when the following occurs:

- High coolant temperature indicator comes on.
- Acceleration becomes sluggish.

If this occurs, pull safely to the side of the road and perform the following procedure. Extended fast idling may cause the high coolant temperature indicator to come on.

NOTICE

Continuing to ride with an overheated engine can cause serious damage to the engine.

1. Stop the engine using the ignition switch.
2. Allow the engine to cool with the ignition switch in the  (Off) position.
3. After the engine has cooled, inspect the radiator hose and check if there is a leak.
 P. 95
If there is a leak:
Do not start the engine. Transport your vehicle to your dealer.
4. Check the coolant level in the reserve tank.  P. 95
 Add coolant as necessary.
5. If 1-4 check normal, you may continue riding, but closely monitor the high coolant temperature indicator.

PGM-FI (Programmed Fuel Injection) Malfunction Indicator Lamp (MIL)

If the indicator comes on while riding, you may have a serious problem with the PGM-FI system. Reduce speed and have your vehicle inspected by your dealer as soon as possible.

ABS (Anti-lock Brake System) Indicator

ADV150A

If the indicator operates in one of the following ways, you may have a serious problem with the ABS. Reduce your speed and have your vehicle inspected by your dealer as soon as possible.

- Indicator comes on or starts flashing while riding.
- Indicator does not come on when the ignition switch is in the **I** (On) position.
- Indicator does not go off at speeds above 10 km/h (6 mph).

If the ABS indicator stays on, your brakes will continue to work as a conventional system, but without the anti-locking function.

The ABS indicator may flash if you turn the rear wheel while the rear wheel is lifted off the ground. In this case, turn the ignition switch to the **O** (Off) position, and then to the **I** (On) position again. The ABS indicator will go off after your speed reaches 30 km/h (19 mph).

Honda SMART Key Indicator

When the Honda SMART Key indicator flashes 5 times

Replacing the Honda SMART Key Battery  P. 104

If the Honda SMART Key indicator is flashing rapidly while the ignition switch is in the (On) position

Start the engine by the normal procedure after pressing the ignition switch again.

 P. 54

When the Honda SMART Key indicator is flashing while the ignition switch is in the (On) position

The Honda SMART Key indicator flashes when communication between your vehicle

and Honda SMART Key stops after turning the ignition switch to the (On) position.

It is probably caused by the following:

- Strong radio waves or noise are affecting the system
- You lose the Honda SMART Key while riding

However, this does not affect the operation of your vehicle until the ignition switch is locked.

If you turn the ignition switch to the SEAT FUEL, (Off) or (Lock) position while the Honda SMART Key indicator is flashing, the ignition switch ring, Honda SMART Key indicator will come on, and the buzzer rings for about 20 seconds, automatically go off, and then the ignition switch is locked.

Warning Indicators On or Flashing ► Honda SMART Key Indicator

- Turn signal lights blink at the beginning and end of this function.

Also, to stop this flashing and ringing, press and hold the ignition switch for more than 2 seconds. After the flashing and ringing stop, the ignition switch is locked.

If you do not have the Honda SMART Key, the ignition switch can be unlocked in another way. ► P. 120

Other Warning Indications

Fuel Gauge Failure Indication

If the fuel system has an error, the fuel gauge indicators will be displayed as shown in the illustrations.

If this occurs, see your dealer as soon as possible.

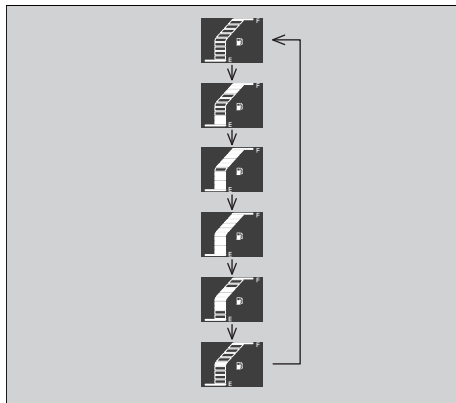
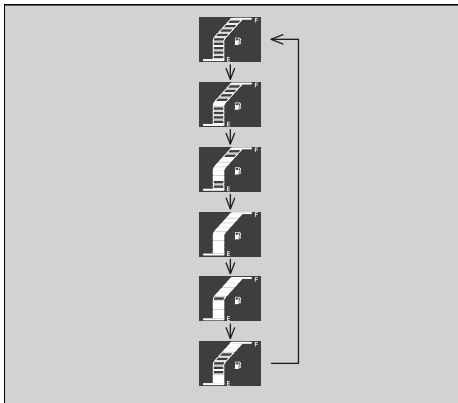

When the Idling Stop System Does Not Operate Properly

Idling Stop Indicator Does Not Come On

When the Idling Stop indicator does not come on, perform the followings.

If the Idling Stop switch is at IDLING:

Press the Idling Stop switch to IDLING STOP.

If the engine is cold:

Warm up the engine.

The Idling Stop system does not operate when the engine is cold.

If you did not ride the vehicle after engine starts:

Ride the vehicle at speeds of over 10 km/h (6 mph). The Idling Stop system does not operate until you ride once.

If PGM-FI malfunction indicator lamp (MIL) lights:

When the PGM-FI malfunction indicator lamp (MIL) lights, the Idling Stop system does not operate for protection of the engine. See your dealer.

If the battery voltage is low:

Ride the vehicle awhile, then stop the engine and then restart the engine with start button referring to the starting procedure (▶ P. 54) for standard engine starting. The Idling Stop system may not operate if the battery voltage is low.

If this occurs frequently, contact your dealer.

Engine is Not Stopped by the Idling Stop System While the Idling Stop Indicator is On

When the engine is not stopped by the Idling Stop system while the Idling Stop indicator is on, perform the followings.

If the vehicle does not stop completely:

Stop the vehicle completely. The Idling Stop system operates if the speed is only at 0 km/h (0 mph).

If the throttle is not closed completely:

Close the throttle completely.

Engine Does Not Start Even If the Throttle is Opened

Engine does not start even if the throttle is opened, perform the followings.

If the side stand is down:

While the engine is stopped by the Idling Stop system, if you operate the side stand, the flashing Idling Stop indicator turns off or stops flashing and stays on, and the Idling Stop system is cancelled. Restart the engine with start button referring to the starting procedure (► P. 54) for standard engine starting.

If the Idling Stop switch is at IDLING:

While the engine is stopping by the Idling Stop system, if you press the Idling Stop switch to IDLING, the Idling Stop system will be cancelled. Restart the engine with start button referring to the starting procedure (► P. 54) for standard engine starting.

If the Idling Stop indicator flashes (the Idling Stop switch is at IDLING STOP position), but engine does not start even if the throttle is opened, perform the followings.

Low (or dead) battery or battery lead is loose:

Check the battery and battery terminals. If the battery is weak, contact your dealer.

When the Honda SMART Key System Does Not Operate Properly

When the Honda SMART Key system does not work properly, perform the following.

- Check that the Honda SMART Key system is activated.

Lightly push the ON/OFF button on the Honda SMART Key.

If the LED of the Honda SMART Key is red, switch the Honda SMART Key system to activation. ➤ P. 34

If the LED of the Honda SMART Key does not respond, replace the battery of the Honda SMART Key.

- Check that there is no communication failure in the Honda SMART Key system. The Honda SMART Key system uses low-intensity radio waves. The Honda SMART Key system may not work properly in the following environments:
 - ▶ When there are facilities nearby that generate strong radio waves or noise such as TV towers, power stations, radio stations, or airports.
 - ▶ When you carry the Honda SMART Key with a laptop or wireless communication device such as a radio or mobile phone.
 - ▶ When the Honda SMART Key comes into contact with or is covered by metal objects.

When the Honda SMART Key System Does Not Operate Properly

- Check that a registered Honda SMART Key is used.
Use a registered Honda SMART Key. The Honda SMART Key system cannot be activated without a registered Honda SMART Key.
- Make sure that you do not use a broken Honda SMART Key.
If you use a broken Honda SMART Key, the Honda SMART Key system cannot be activated. Bring the emergency key and ID tag to your dealer.

- Check the battery condition and battery lead in your vehicle.
Check the battery and battery terminals. If the battery is weak, contact your dealer.

If the Honda SMART Key system cannot be activated due to other causes, contact your dealer.

Unlock the Seat in an Emergency

The seat lock can be unlocked by using the emergency key.

Open

1. Remove the front lid.  P. 87
2. Align the projection of the emergency key with the slot of the emergency seat opener, and turn the emergency key counterclockwise.
3. Open the seat and turn the emergency key clockwise

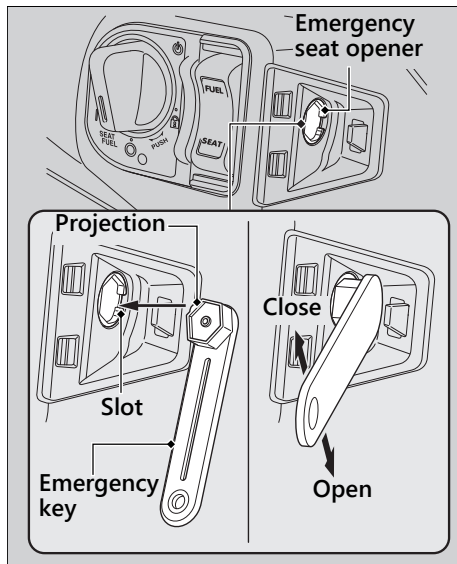

Close

1. Close and push down on the rear of the seat until it locks. Make sure that the seat is locked securely by pulling it up lightly. If the seat is not locked, turn the emergency key clockwise to lock the seat catch.
2. Install the front lid.





Unlock the Ignition Switch in an Emergency

Set up to ID number input mode

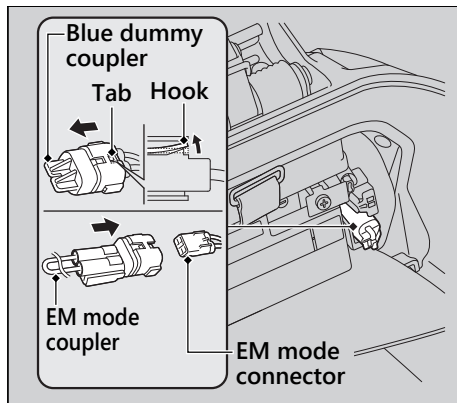
1. Use the emergency key to open the seat.  P. 119
2. Remove the battery cover.  P. 85
3. Pull the battery rubber down.  P. 84
4. Pull out the EM mode connector.
5. Remove the blue dummy coupler by releasing the tab of the EM mode connector while lifting the hook of the blue dummy coupler.
6. Check the ID number on the ID tag.
7. Connect the EM mode coupler provided in the tool kit to the EM mode connector.



ID number input

You can input your ID number by pressing the ignition switch when the ignition switch is  (Off),  (Lock) and SEAT FUEL position. Input the ID number on the ID tag in order from the left in turn by pressing the ignition switch.

The ID number is authenticated according to the number of times the ignition switch is pushed.

Push the ignition switch the desired number of times within 5 seconds when the ignition switch ring comes on. After 5 seconds, the ignition switch ring goes off and comes on again. This means that the inputted number is fixed, and you can input the next number.

- ▶ If the ignition switch ring does not come on in blue, the battery may be low. Contact your dealer.

Example:

- To input "0", wait for 5 seconds without pushing the ignition switch when the ignition switch ring comes on.
- To input "1", push the ignition switch once within 5 seconds when the ignition switch ring comes on.

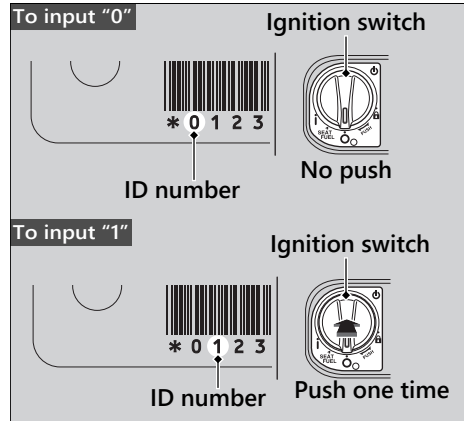

Unlock the Ignition Switch in an Emergency

ID number input success

After the last ID number is inputted, through, the ignition switch ring and Honda SMART Key Indicator will flash every 2 seconds until the EM mode coupler is removed.

Be sure to remove the EM mode coupler and return the blue dummy coupler. Buzzer rings 2 times when the EM mode coupler was removed. The ignition switch is then unlocked. Reinstall the parts in reverse order of removal and turn the ignition switch to the **I** (On) position within 6 minutes. You can start the engine.

To lock the ignition switch, turn the ignition switch to the SEAT FUEL, **O** (Off), or **L** (Lock) position, and press and hold the ignition switch for 2 seconds. Buzzer rings 1 time. The ignition switch also locks automatically when the ignition switch has been in the SEAT FUEL, **O** (Off), or **L** (Lock) position for about 6 minutes after the ID number is successfully inputted.

When the ignition switch is locked, the ignition switch ring goes off.

To unlock the ignition switch again, repeat the procedure for unlocking the ignition switch.

ID number input failure

After the last ID number is inputted, the ignition switch ring and Honda SMART Key Indicator will flash every second until the EM mode coupler is removed, and the ignition switch cannot be unlocked.

Pull out the EM mode coupler and reconnect it to the EM mode connector. Follow the procedure again. ➔ P. 121

ID number input cancel

Pull out the EM mode coupler from the EM mode connector.

Also, if you make a mistake while inputting the ID number, remove the EM mode coupler from the EM mode connector, connect it to the EM mode connector again, and then re-input the ID number from the beginning.

- Store the removed EM mode coupler in the tool kit at all times.

Tyre Puncture

Repairing a puncture or removing a wheel requires special tools and technical expertise. We recommend you have this type of service performed by your dealer.

After an emergency repair, always have the tyre inspected/replaced by your dealer.

Emergency Repair Using a Tyre Repair Kit

If your tyre has a minor puncture, you can make an emergency repair using a tubeless tyre repair kit.

Follow the instructions provided with the emergency tyre repair kit.

Riding your vehicle with a temporary tyre repair is very risky. Do not exceed 50 km/h (30 mph). Have the tyre replaced by your dealer as soon as possible.

WARNING

Riding your vehicle with a temporary tyre repair can be risky. If the temporary repair fails, you can crash and be seriously injured or killed.

If you must ride with a temporary tyre repair, ride slowly and carefully and do not exceed 50 km/h (30 mph) until the tyre is replaced.

Battery Goes Dead

Charge the battery using a motorcycle battery charger.

Remove the battery from the vehicle before charging.

Do not use an automobile-type battery charger, as these can overheat a motorcycle battery and cause permanent damage. If the battery does not recover after recharging, contact your dealer.

NOTICE

Jump starting using an automobile battery can damage your vehicle's electrical system and is not recommended.

Burned-out Light Bulb

All light bulbs on the vehicle are LEDs. If there is an LED which is not turned on, see your dealer for servicing.

Headlights/Front Turn Signals/ Position Lights

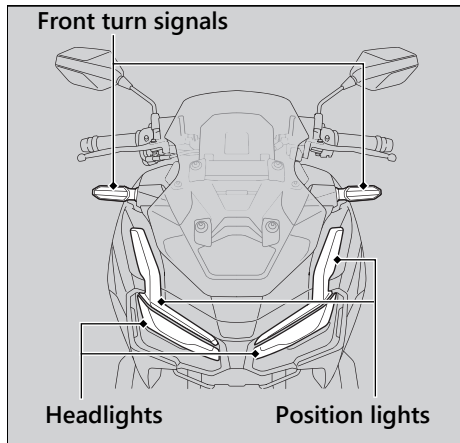

The headlight/front turn signals/position lights use several LEDs. If there is a LED which is not turned on, see your dealer for servicing.

Brakelight/Taillight/Rear Turn Signals/License Plate Light

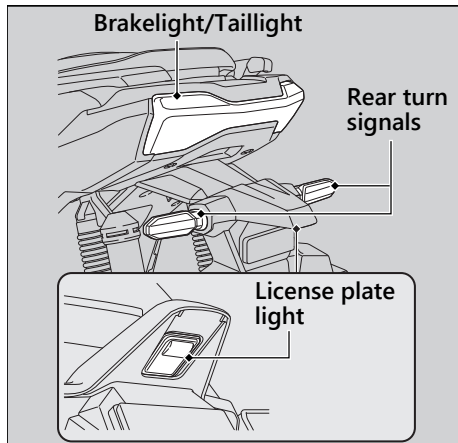

The brakelight/taillight/rear turn signals/license plate light use several LEDs. If there is a LED which is not turned on, see your dealer for servicing.

Blown Fuse

Before handling fuses, see "Inspecting and Replacing Fuses." ► P. 76

Fuse Box Fuses

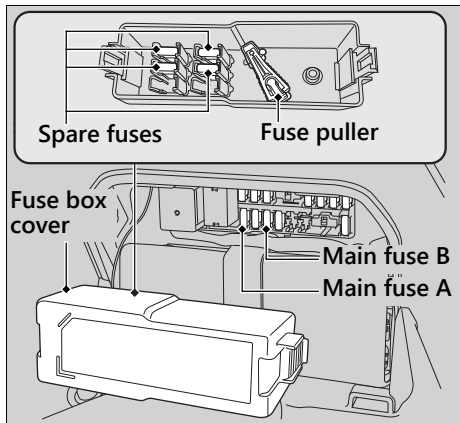

1. Remove the battery cover. ► P. 85
2. Open the fuse box cover.
3. Pull the main fuse and other fuses out one by one with the fuse puller located inside of the fuse box cover. Check for a blown fuse. Always replace a blown fuse with a spare fuse of the same rating.
4. Install the fuse box cover.
5. Install the battery cover.

NOTICE

If a fuse fails repeatedly, you likely have an electrical problem. Have your vehicle inspected by your dealer.

Unstable Engine Operation Occurs Intermittently

If the fuel pump filter is clogged, unstable engine operation will occur intermittently while riding.

Even if this symptom occurs, you can continue to ride your vehicle.

If unstable engine operation occurs even if sufficient fuel is available, have your vehicle inspected by your dealer as soon as possible.

Information

Keys.....	P. 129
Instruments, Controls, & Other Features...	P. 132
Caring for Your Vehicle.....	P. 133
Storing Your Vehicle.....	P. 137
Transporting Your Vehicle	P. 138
You & the Environment	P. 139
Serial Numbers	P. 140
Fuels Containing Alcohol	P. 141
Catalytic Converter	P. 142

Keys

Emergency Key

The emergency key is used for an emergency.

- To unlock the seat. ➤ P. 119
- To unlock the ignition switch. ➤ P. 120

Do not store the emergency key in any compartment.

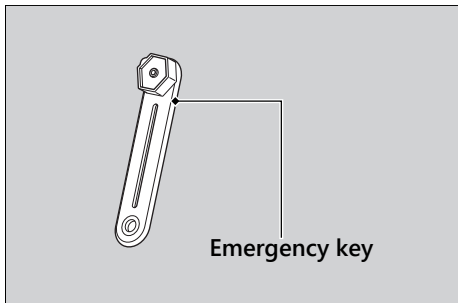

Honda SMART Key

Carrying the Honda SMART Key allows you to perform the following operations:

- Locking or unlocking the ignition switch
- Releasing the seat lock
- Opening the fuel lid
- Locking or unlocking the steering

The ID number of the Honda SMART Key is on the ID tag. You can also unlock the ignition switch by inputting the ID number.

Always carry both the emergency key and ID tag, but separate from the Honda SMART Key, to avoid losing all of them at the same time.

Also store a copy of your ID number in a safe place other than your vehicle.

The Honda SMART Key contains electronic circuits. If the circuits are damaged, the Honda SMART Key will not allow you to perform any operations.

- Do not drop the Honda SMART Key or set heavy objects on them.
- Protect the Honda SMART Key from direct sunlight, high temperature, and high humidity.
- Do not scratch or puncture.
- Do not store near any magnetized products such as a magnetized key chain.
- Always keep the Honda SMART Key away from electric appliances such as a TV, radio, PC or low-frequency massage device.
- Keep the Honda SMART Key away from liquids. If it gets wet, dry it immediately with a soft cloth.
- Keep the Honda SMART Key away from the vehicle while washing the vehicle.
- Do not burn.
- Do not wash in the ultrasonic cleaner.

- If fuel, wax, or grease adhere to the Honda SMART Key, wipe it off immediately to avoid cracking or warping.
- Do not disassemble the Honda SMART Key other than when changing a battery. Only the cover of the Honda SMART Key can be disassembled. Do not disassemble other parts.
- Do not lose your Honda SMART Key. If you lose it, you will need to register a new Honda SMART Key. See your dealer with your emergency key and ID tag for registration.

The battery in the Honda SMART Key system normally lasts about 2 years.

Do not keep mobile phones or other radio transmitting devices in any compartment. The radio frequency from the devices will interrupt the Honda SMART Key system.

To get an additional Honda SMART Key, take the Honda SMART Key and the vehicle to your dealer.

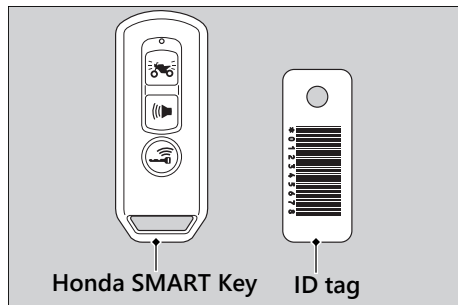

Instruments, Controls, & Other Features

Ignition Switch

Leaving the ignition switch in the **I** (On) position with the engine stopped will drain the battery.

Do not turn the ignition switch while riding.

Odometer

The display locks at 999,999 when the read-out exceeds 999,999.

Tripmeter

The tripmeter A and B return to 0.0 when the read-out exceeds 9,999.9, also average fuel mileage and fuel consumption are reset at the same time.

Document Bag

The owner's manual, registration, and insurance information can be stored in the plastic document bag located underside of the seat.

Caring for Your Vehicle

Frequent cleaning and polishing is important to ensure the life of your Honda. A clean vehicle makes it easier to spot potential problems. In particular, seawater and salts used to prevent ice on roads promote the formation of corrosion. Always wash your vehicle thoroughly after riding on coastal or treated roads.

Washing

Allow the engine, muffler, brakes, and other high-temperature parts to cool before washing.

1. Rinse your vehicle thoroughly using a low pressure garden hose to remove loose dirt.
2. If necessary, use a sponge or a soft towel with mild cleaner to remove road grime.
 - ▶ Clean the windscreen, headlight lens, panels, and other plastic components with extra care to avoid scratching them. Avoid directing water into the air cleaner, muffler, and electrical parts.

3. Thoroughly rinse your vehicle with plenty of clean water and dry with a soft, clean cloth.
4. After the vehicle dries, lubricate any moving parts.
 - ▶ Make sure that no lubricant spills onto the brakes or tyres. Brake discs, pads, drum or shoes contaminated with oil will suffer greatly reduced braking effectiveness and can lead to a crash.
5. Apply a coat of wax to prevent corrosion.
 - ▶ Avoid products that contain harsh detergents or chemical solvents. These can damage the metal, paint, and plastic on your vehicle. Keep the wax clear of the tyres and brakes.
 - ▶ If your vehicle has any mat painted parts, do not apply a coat of wax to the mat painted surface.

Washing Precautions

Follow these guidelines when washing:

- Do not use high-pressure washers:
 - ▶ High-pressure water cleaners can damage moving parts and electrical parts, rendering them inoperable.
 - ▶ Water in the air intake can be drawn into the throttle body and/or enter the air cleaner.
 - Do not direct water at the muffler:
 - ▶ Water in the muffler can prevent starting and causes rust in the muffler.
 - Dry the brakes:
 - ▶ Water adversely affects braking effectiveness. After washing, apply the brakes intermittently at low speed to help dry them.
 - Do not direct water under the seat:
 - ▶ Water in the under seat compartment can damage your documents and other belongings.
-
- Do not direct water at the air cleaner:
 - ▶ Water in the air cleaner can prevent the engine from starting.
 - Do not direct water near the headlight:
 - ▶ The headlight's inside lens may fog temporarily after washing or while riding in the rain. This does not impact the headlight function.
However, if you see a large amount of water or ice accumulated inside the lens(es), have your vehicle inspected by your dealer.
 - Do not use wax or polishing compounds on mat painted surface:
 - ▶ Use a soft cloth or sponge, plenty of water, and a mild detergent to clean mat painted surfaces. Dry with a soft clean cloth.

Aluminium Components

Aluminium will corrode from contact with dirt, mud, or road salt. Clean aluminium parts regularly and follow these guidelines to avoid scratches:

- Do not use stiff brushes, steel wool, or cleaners containing abrasives.
- Avoid riding over or scraping against curbs.

Panels

Follow these guidelines to prevent scratches and blemishes:

- Wash gently using a soft sponge and plenty of water.
- To remove stubborn stains, use diluted detergent and rinse thoroughly with plenty of water.
- Avoid getting petrol, brake fluid, or detergents on the instruments, panels, or headlight.

Windscreen

Using plenty of water, clean the windscreen with a soft cloth or sponge. (Avoid using detergents or any kind of chemical cleaner on the windscreen.) Dry with a soft, clean cloth.

NOTICE

To avoid possible scratching or other damage, use only water and a soft cloth or sponge to clean the windscreen.

For a dirtier windscreen, use a diluted neutral detergent with a sponge and plenty of water. Make sure to wash off all the detergent. (Detergent residue may cause windscreen cracks.)

Replace the windscreen if scratches cannot be removed and they obstruct clear vision.

Take care to keep battery electrolyte, brake fluid, or other chemical solvents off the windscreen and screen garnish. They will damage the plastic.

Exhaust Pipe and Muffler

When the exhaust pipe and muffler are painted, do not use a commercially available abrasive kitchen cleaning compound. Use a neutral detergent to clean the painted surface on the exhaust pipe and muffler. If you are not sure if your exhaust pipe and muffler are painted, contact your dealer.

Storing Your Vehicle

If you store your vehicle outdoors, you should consider using a full-body cover.

If you won't be riding for an extended period, follow these guidelines:

- Wash your vehicle and wax all painted surfaces (except mat painted surfaces). Coat chrome pieces with rust-inhibiting oil.
- Place your vehicle on its centre stand and position a block so that both tyres are off the ground.
- After rain, remove the body cover and allow the vehicle to dry.
- Remove the battery (➔ P. 84) to prevent discharge. Fully charge the battery and then place it in a shaded, well-ventilated area.
 - ▶ If you leave the battery in place, disconnect the negative ⊖ terminal to prevent discharge.

After removing your vehicle from storage, inspect all maintenance items required by the Maintenance Schedule.

Transporting Your Vehicle

If your vehicle needs to be transported, it should be carried on a motorcycle trailer or a flatbed truck or trailer that has a loading ramp or lifting platform, and motorcycle tie-down straps. Never try to tow your vehicle with a wheel or wheels on the ground.

NOTICE

Towing your vehicle can cause serious damage to the transmission.

You & the Environment

Owning and riding a vehicle can be enjoyable, but you must do your part to protect the environment.

Choose Sensible Cleaners

Use a biodegradable detergent when you wash your vehicle. Avoid aerosol spray cleaners that contain chlorofluorocarbons (CFCs) which damage the atmosphere's protective ozone layer.

Recycle Wastes

Put oil and other toxic wastes in approved containers and take them to a recycling centre. Call your local or state office of public works or environmental services to find a recycling centre in your area, and to get instructions on how to dispose of non-recyclable wastes. Do not place used engine oil in the trash, or pour it down a drain or on the ground. Used oil, petrol, coolant, and cleaning solvents contain poisons that can hurt refuse workers and contaminate drinking water, lakes, rivers, and oceans.

Serial Numbers

The frame and engine serial numbers uniquely identify your vehicle and are required in order to register your vehicle. They may also be required when ordering replacement parts. To check the frame number, open the seat.

➤ P. 64

You should record these numbers and keep them in a safe place.

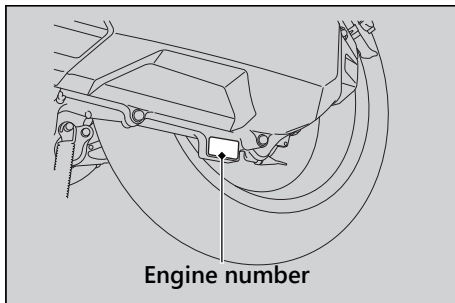
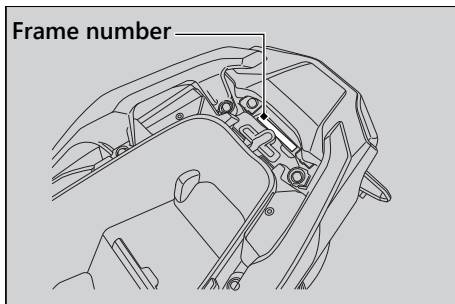

Fuels Containing Alcohol

Some conventional fuels blended with alcohol are available in some locales to help reduce emissions to meet clean air standards. If you plan to use blended fuel, check that it is unleaded and meets the minimum octane rating requirement.

The following fuel blends can be used in your vehicle:

- Ethanol (ethyl alcohol) up to 10% by volume.
 - ▶ Petrol containing ethanol may be marketed under the name Gasohol.

The use of petrol containing more than 10% ethanol may:

- Damage the painting of the fuel tank.
- Damage the rubber tubes of the fuel line.
- Cause corrosion of the fuel tank.
- Cause poor drivability.

NOTICE

Use of blended fuels containing higher than approved percentages can damage metal, rubber, plastic parts of your fuel system.

If you notice any undesirable operating symptoms or performance problems, try a different brand of petrol.

Catalytic Converter

This vehicle is equipped with a three-way catalytic converter. The catalytic converter contains precious metals that serve as catalysts in high temperature chemical reactions that convert hydrocarbons (HC), carbon monoxide (CO), and oxides of nitrogen (NOx) in the exhaust gasses into safe compounds.

A defective catalytic converter contributes to air pollution and can impair your engine's performance. A replacement unit must be an original Honda part or equivalent.

Follow these guidelines to protect your vehicle's catalytic converter.

- Always use unleaded petrol. Leaded petrol will damage the catalytic converter.
- Keep the engine in good running condition.
- Have your vehicle serviced if your engine is misfiring, backfiring, stalling, or otherwise not running properly, stop riding and turn off the engine.

Specifications

■ Main Components

Overall length	1,950 mm (76.8 in)		
Overall width	763 mm (30.0 in)		
Overall height	1,153 mm (45.4 in)		
Wheelbase	1,324 mm (52.1 in)		
Minimum ground clearance	165 mm (6.5 in)		
Caster angle	26° 30'		
Trail	85 mm (3.3 in)		
Curb weight	ADV150	132 kg (291 lb)	
	ADV150A	133 kg (293 lb)	
Maximum weight capacity *1	IN	150 kg (331 lb)	
	PH, II PH	140 kg (309 lb)	
Maximum luggage weight *2	Centre compartment	10 kg (22 lb)	
	Front box	IN	1.0 kg (2.2 lb)
		PH, II PH	1.0 kg (2.0 lb)
Passenger capacity	Rider and 1 passenger		
Minimum turning radius	1.90 m (6.2 ft)		

*1 : Including rider, passenger, all luggage, and accessories.

*2 : Includes the weight of the luggage and added accessories.

Displacement	IN	149.32 cm ³ (9.109 cu-in)
	PH, II PH	149 cm ³ (9.1 cu-in)
Bore x stroke	57.300 x 57.907 mm (2.2559 x 2.2798 in)	
Compression ratio	10.6:1	
Fuel	Unleaded petrol Recommended: 88 RON or higher	
Fuel containing alcohol	ETHANOL up to 10 % by volume	
Tank capacity	8.0 L (2.11 US gal, 1.76 Imp gal)	
Battery	YTZ6V 12 V-5.0 Ah (10 HR)	
	GTZ6V 12 V-5.0 Ah (10 HR)	
Primary reduction	V-Matic (2.52:1 to 0.81:1)	
Final reduction	9.854	

Specifications

■ Service Data

Tyre size	Front	110/80-14M/C 53P
	Rear	130/70-13M/C 57P
Tyre type	Bias-ply, tubeless	
Recommended Tyres	Front	SRI FT297
	Rear	SRI FT297
Tyre air pressure (Drivers only)	Front	200 kPa (2.00 kgf/cm ² , 29 psi)
	Rear	225 kPa (2.25 kgf/cm ² , 33 psi)
Tyre air pressure (Driver and passenger)	Front	200 kPa (2.00 kgf/cm ² , 29 psi)
	Rear	225 kPa (2.25 kgf/cm ² , 33 psi)
Minimum tread depth	Front	1.5 mm (0.06 in)
	Rear	2.0 mm (0.08 in)
Spark plug	MR8K-9 (NGK)	
Spark plug gap	0.8 - 0.9 mm (0.03 - 0.04 in)	
Idle speed	1,700 ± 100 rpm	
Recommended engine oil	Honda 4-stroke motorcycle oil API Service Classification SG or higher, excluding oils marked as "Energy Conserving" or "Resource Conserving," SAE 10W-30, JASO T 903 standard MB	

Engine oil capacity	After draining	0.8 L (0.8 US qt, 0.7 Imp qt)
	After draining & cleaning strainer screen	0.8 L (0.8 US qt, 0.7 Imp qt)
	After disassembly	0.9 L (1.0 US qt, 0.8 Imp qt)
Transmission oil capacity	After draining	0.12 L (0.13 US qt, 0.11 Imp qt)
	After disassembly	0.14 L (0.15 US qt, 0.12 Imp qt)
Recommended brake fluid	Honda DOT 3 or DOT 4 Brake Fluid	
Cooling system capacity	0.48 L (0.51 US qt, 0.42 Imp qt)	
Recommended coolant	HONDA PRE-MIX COOLANT	

■ Bulbs

Headlight	LED
Brakelight/Taillight	LED
Front turn signal	LED
Rear turn signal	LED
License plate light	LED
Position light	LED

■ Fuses

Main fuse A	25 A
Main fuse B	15 A
Other fuse	ADV150 7.5 A, 2A
	ADV150A 15A, 7.5 A, 2A

■ Torque Specifications

Oil plug	20 N·m (2.0 kgf·m, 15 lbf·ft)
Engine oil drain bolt	24 N·m (2.4 kgf·m, 18 lbf·ft)

A

- ABS (Anti-lock Brake System)** 8, 110
- ABS (Anti-lock Brake System) Indicator**..... 28
- Accessories**..... 11

B

- Battery**..... 74, 84
- Brakes**
 - Fluid..... 78, 97
 - Pad Wear 98
- Braking** 7

Bulb

- Brake/Tail Light 125
- Front Turn Signal Light..... 125
- Headlight 125
- License Plate Light..... 125
- Position Light..... 125
- Rear Turn Signal Light 125

C

- Catalytic Converter**..... 142
- Centre Compartment**..... 66
- Clock** 17
- Compartment**

- Document Bag 132
- Owner's Manual 132

- Coolant**..... 95
- Crankcase Breather** 101

D

- Display Setting** 22
- Document Bag** 66, 132

E

Emergency

- Emergency Key..... 129
- Unlock the Seat 119

Engine

- Number..... 140

- Electrical Trouble** 124

- Environment** 139

F

- Flooded Engine** 54
- Frame Number** 140
- Front Box** 67

Fuel	
Gauge	17
Recommended	61
Remaining	17
Tank Capacity	61
Fuses	76, 126
G	
Gasohol	141
H	
Hazard Switch	30
Headlight Aim	102
Headlight Dimmer Switch	30
Helmet Holder	65
High Beam Indicator	26
High Coolant Temperature Indicator	26
Honda SMART Key	130
Honda SMART Key Indicator	27
Honda SMART Key System	33
Horn Button	30
I	
Idling Stop Indicator	26
Idling Stop Switch	30
Idling Stop System	51
Ignition Cut-off System	
Side Stand	99
Ignition Switch	31, 132
Indicators	26
Instruments	16
K	
Key	
Emergency Key	129
Honda SMART	33
L	
Load Limits	12
Loading Guidelines	12
M	
Maintenance	
Fundamentals	73
Importance	69
Safety	69
Schedule	70
Maximum Weight Limit	12, 143

Modifications	11	Battery.....	84
O		Battery Cover	85
Odometer	18, 132	Clip.....	86
Oil		Front Lid	87
Engine	77, 91	Repair Kit	123
OIL CHANGE indicator	19	Riding Precautions	7
Overheating	108	S	
P		Safety Precautions	6
Parking	9	Seat	64
Parts Location	14	Serial Numbers	140
Petrol	10, 61, 143	Side Stand	99
PGM-FI (Programmed Fuel Injection)		Side Stand Ignition Cut-off System	54, 99
Malfunction Indicator Lamp (MIL)	28, 109	Spark Plug	88
Protective Apparel	6	Specifications	143
R		Speedometer	17
Recommended		Start Button	30
Coolant.....	78	Starting the Engine	54
Fuel.....	61	Storage	
Oil	77	Centre Compartment.....	66
Refuelling	61	Equipment	64
Removal		Front Box.....	67
		Owner's Manual	66, 132
		Tool Kit.....	66

Storing.....	137
Switches	30

T

Throttle	100
Tool	83
Transporting	138
Tripmeter.....	18, 132
Troubleshooting	106
Turn Signal Indicators	27
Turn signal switch.....	30

Tyres

Air Pressure	79, 144
Puncture.....	123
Replacing	79

W

Warning Indicator On.....	109
Washing Your Vehicle	133
Weight Limit	12

HONDA

The Power of Dreams

For Comments and Suggestions you may contact us at:

Honda Philippines, Inc.

Head Office & Manufacturing Plant

Lot 34 Phase 1 - B Road 3,

First Philippine Industrial Park,

Tanauan City 4234 Batangas

Tel. Nos. (632) 581-6700 to 99

Tel. Nos. (632) 756-7300 to 59

Email : customerservice@hondaph.com

Website: www.hondaph.com

32K0WA000

PRINTED IN THE PHILIPPINES